

 SUPAIR

English



WALIBI 3

User's manual

SUPAIR SAS
PARC ALTAÏS
34 RUE ADRASTÉE
74650 ANNECY CHAVANOD
FRANCE

RCS 387956790

Revision index : V1 13/08/2020



Thank you for choosing the WALIBI 3. We are glad to be able to share our common paragliding passion with you.

SUPAIR has been designing, producing and selling free flying equipment since 1984. By choosing a SUPAIR product you benefit from almost thirty years of expertise, innovation and listening. This is also our philosophy : working endlessly to develop better products and to maintain a high quality production.

We hope you will find this user's manual comprehensive, explicit and hopefully enjoyable as well. We advise you to read it carefully.

You will find the latest up to date information about this product on our website **www.supair.com**.

If you have any further questions, feel free to ask one of our retailers for answers. And naturally, the entire SUPAIR team is at your disposal on **info@supair.com**.

We wish you many safe enjoyable flying hours, and happy landings

Team SUPAIR



LIST OF CONTENTS

Introduction	4	Pre-Flight check	32
Technical specifications	5	Take-off	32
Size choice	6	In flight	33
Nomenclature	7	Landing	33
Harness Overview	8	Using the reserve parachute	34
Accessories assembly	9	Towing	34
Carabiners	9	Mandatory controls	34
Neoprene sleeve	9	In case of an incident	35
Backrest protection	11	Maintenance	36
Bumpair	12	Harness cleaning and maintenance	36
Installing the reserve parachute	13	Storage and transport	36
Reserve parachute characteristics	13	Product longevity	36
POD reserve parachute handle connection	13	Repairs / spare parts	37
Parachute risers – harness connection	14	Materials	37
Place the risers inside the neoprene sleeve	16	Recycling	37
Place the risers inside the sleeve	17	Warranty	38
Riser connection – reserve parachute	18	Disclaimer	38
Installing the reserve parachute in the container	19	Pilot's gear	38
Locking the reserve parachute handle	26	Shock Absorber	39
Gear packing and tips	28	Service Book	40
Adjustments	29		
The various adjustments	29		
Adjusting the harness	30		
Wing/harness Connection	31		
Flight phases	32		

Welcome to the world of paragliding according to SUPAIR, a world of shared passion.

The Walibi 3 harness is aimed at professional pilots and flying enthusiasts. Comfort, lightness and durability dictated its design and the materials chosen by our R&D team.

The WALIBI 3 harness was certified EN 1651 : 2018 and LTF Nfl II 91/09. Indicating that it meets European and German safety requirements.

After reading this manual, we suggest you to check your harness in static hang-posts to adjust it before your first flight.

N.B : Three important icons will help you when reading this manual :



Advice



Caution !



Danger !!



TECHNICAL SPECIFICATIONS

Harness size		SM	L
	Pilot size (cm)	160-180	175-200
	Pilot weight (mini - maxi) (kg)	60 - 85	80 - 120
	Harness weight (+ carabiners+speedbar)(kg)	3,15	3,19
	Designed for	Tandem (pilot)	
A	Back lenght (cm)	63	70
B	Backrest tilt adjustment (cm)	32	36
C	Seat length (cm)	46	49
D	Carabiners height (cm)	42	45
E	Carabiners distance (cm)	45	48
	Impact damping system	BUMPAIR	
	Certification	EN 1651 : 2018 - LTF Nfl II 91/09	
	Tandem (Pilot or Passenger)	Pilot	
	Towing	No	
	Quick-out carabiners compatibility	No	
	Reserve parachute pocket volume (liter)	7 to 10,4	

A

Back lenght

D

Carabiners height

B

Backrest tilt adjustment

E

Carabiners distance

C

Seat length

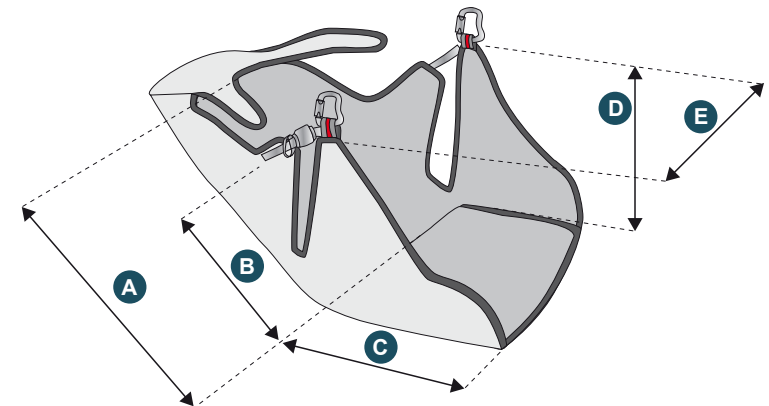

SIZE CHOICE

Choosing your harness size is important. You will find here below a height/weight table that will help you in your size choice. With its hammock architecture and its "lying flat" flying position, we advise you to try out the harness under a hanging device at one of our retailers in order to choose the correct size.

For a complete list of our retailers, please click here : www.supair.com

Taille Poids	1m60	1m65	1m70	1m75	1m80	1m85	1m90	1m95	2m00
50									
55		SM	SM						
60		SM	SM						
65	SM	SM	SM	SM					
70	SM	SM	SM	SM	SM				
75	SM	SM	SM	SM	SM		L		
80		SM	SM	SM		L	L		
85			SM		L	L	L	L	L
90				L	L	L	L	L	L
95					L	L	L	L	L
100						L	L	L	L
110						L	L	L	L
120						L	L	L	L

 Preliminary test under hanging device

NOMENCLATURE



- 1 Harness
- 2 2x 45 mm Zical self-locking carabiners
- 3 Camera pocket
- 4 Bumpair WI3
- 5 POWI3 reserve parachute handle
- 6 Pre-cut parachute risers sleeves

Options

TANDEM DYNEEMA PARACHUTE
RISERS
(réf. : ELEBIY)

HARNESS OVERVIEW

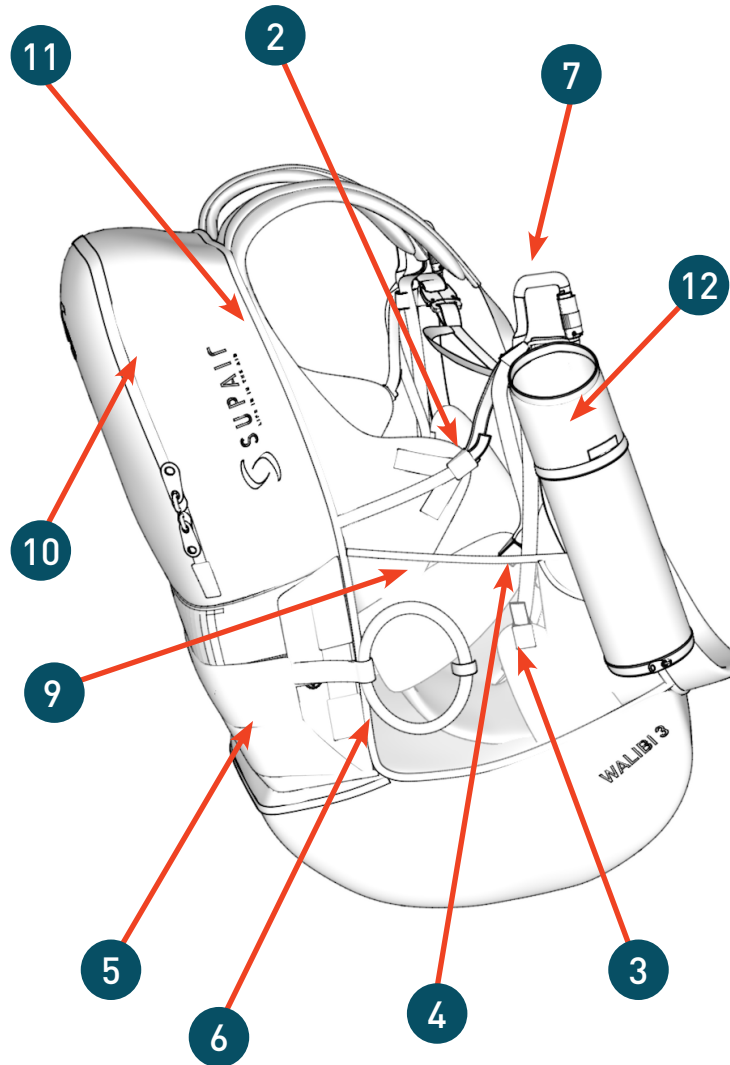
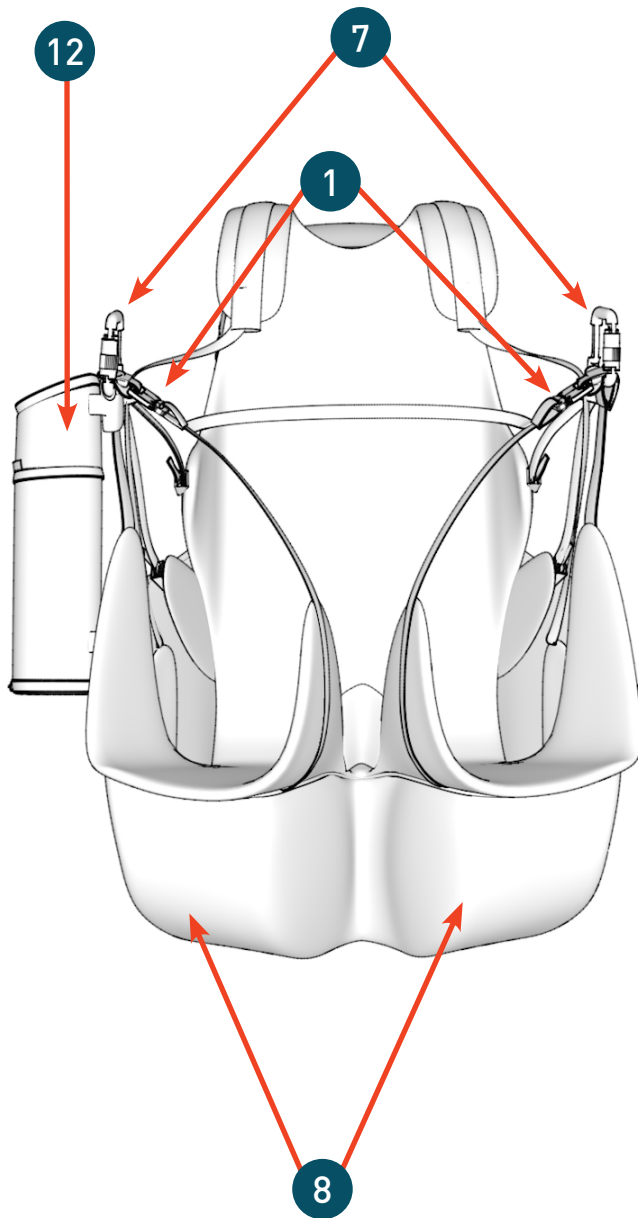

- 1 Cobra © buckles (chest & legs)
- 2 Backrest angle adjustment
- 3 Shoulder strap adjustment
- 4 Lumbar support adjustment
- 5 Reserve parachute pocket
- 6 Reserve parachute handle
- 7 Paragliding main hooking points
- 8 Bumpair
- 9 Small storage pocket
- 10 Back storage pocket
- 11 Backrest protection
- 12 Camera pocket

Carabiners

Compatible carabiners :

45 mm Self-locking zicral carabiners

Réf. : MAILCOMOUS45

Pass the carabiners through the 2 main attach points

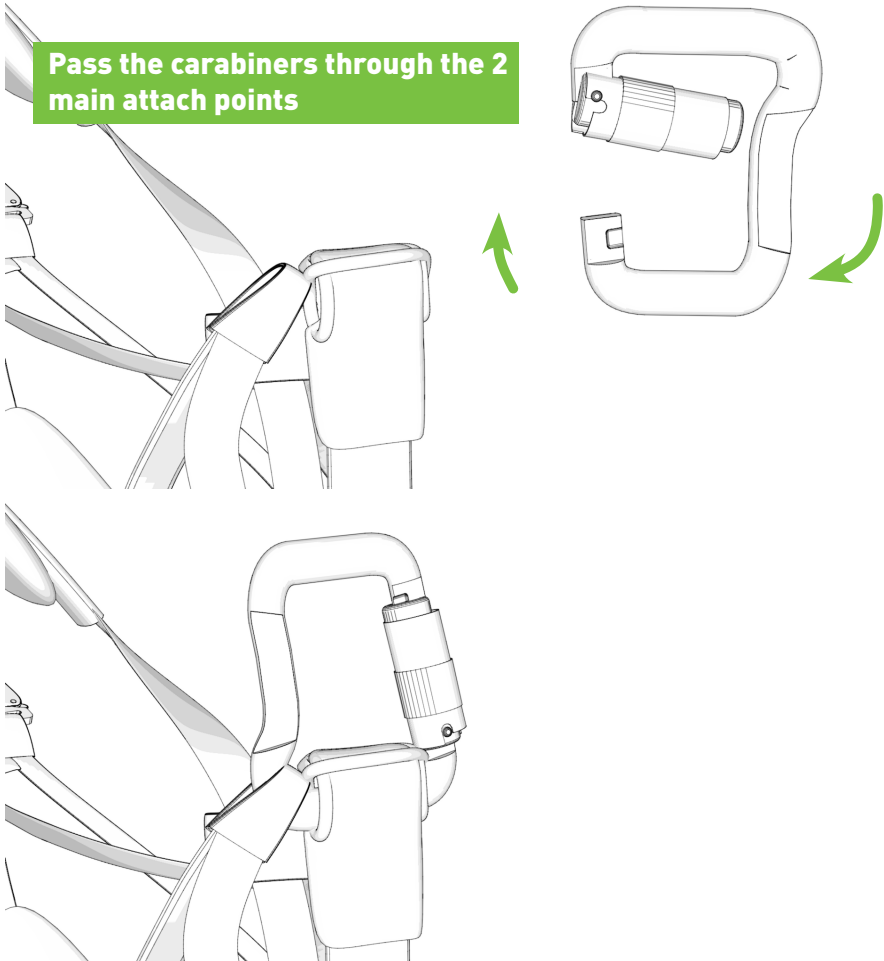

The Walibi 3 is designed with only the main attachment point for the carabiner. Do not attach yourself to any other place of the harness. There is no rescue attachment point and no towing attachment point.

ACCESSORIES ASSEMBLY

Tearable neoprene sleeve

Neoprene sleeve :

Réf. : GAINEELEVW3

How to set up the shoulder straps inside the sleeve

1. Detach the shoulder strap

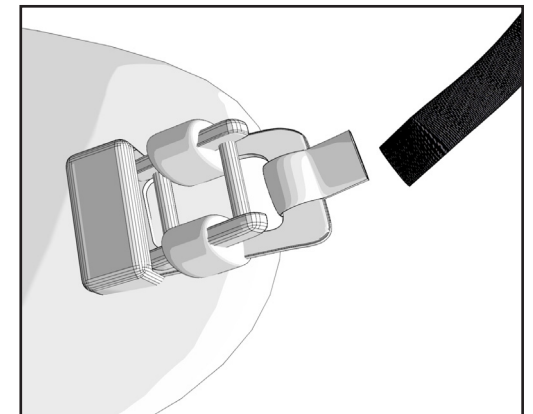
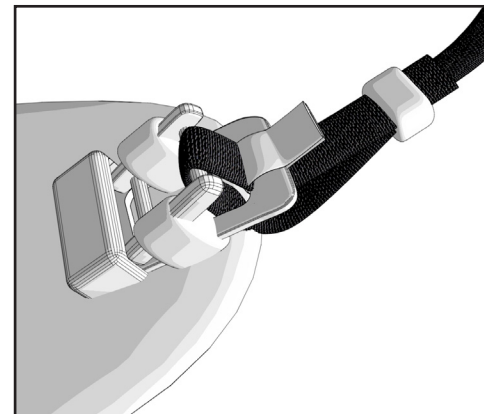
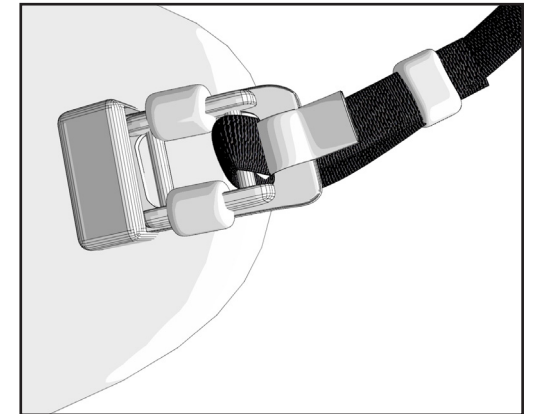
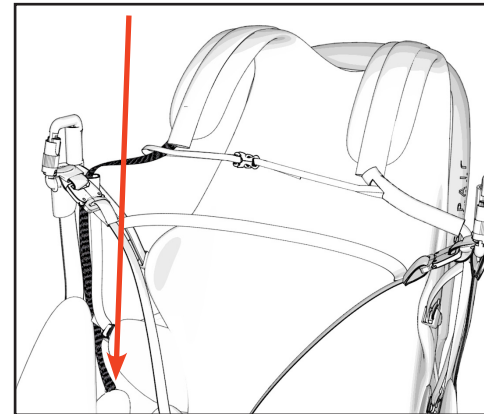

ACCESSORIES ASSEMBLY

Tearable neoprene sleeve

2. Insert the sleeve

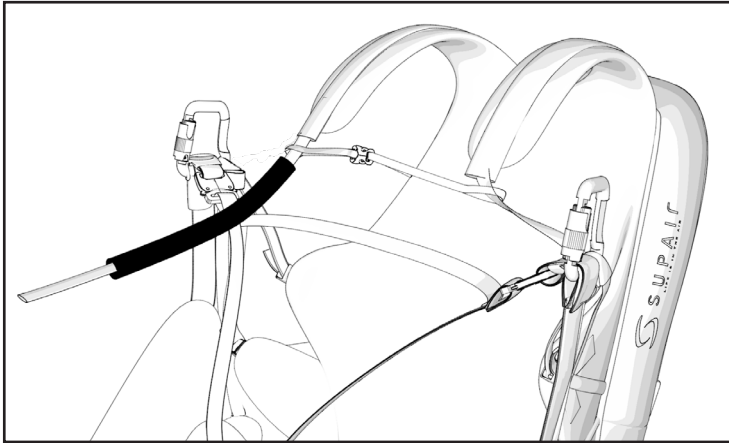

3. Take out the comfort chest strap

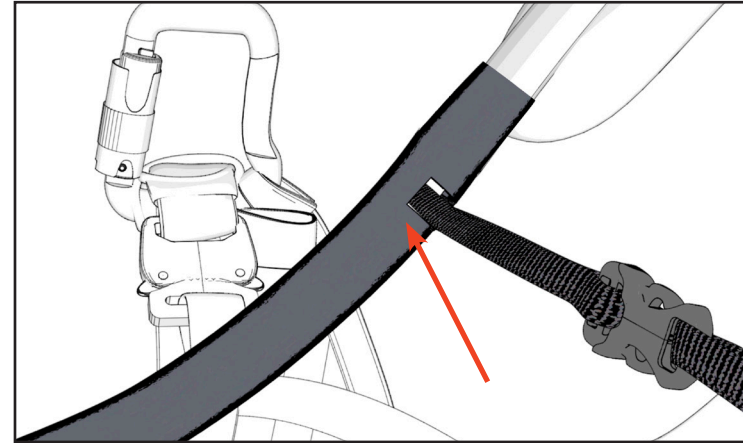

4. Take out the shoulder strap

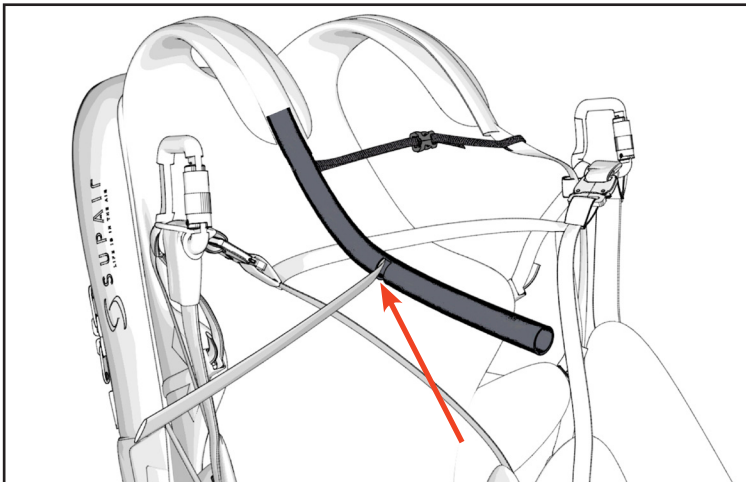

5. Attach the shoulder straps and do the same on the other side

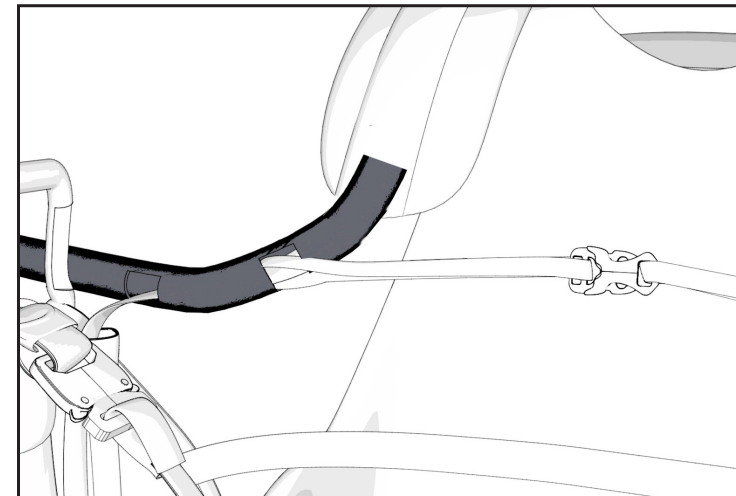

ACCESSORIES ASSEMBLY

Tearable neoprene sleeve

How to install the sleeves on the spreader bars

1. Connect the spreader bars to the Walibi 3

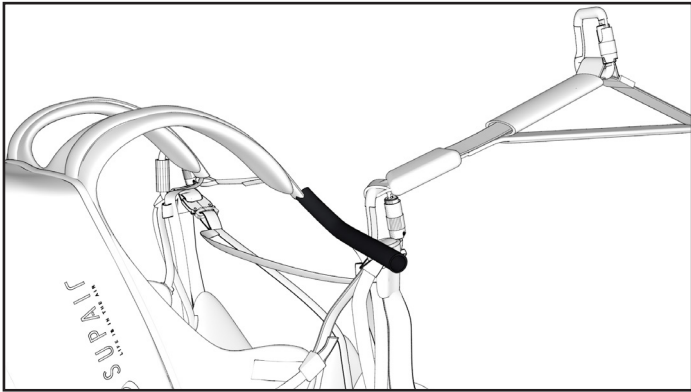

2. Install the sleeve on the spreader bar

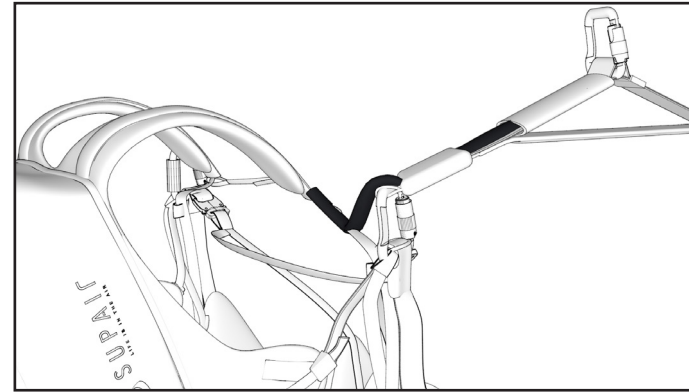

Backrest protection

Install the backrest protection

1. Open the dorsal pocket zip



2. Insert the back protection and close the zip



BUMPAIR

Compatible BUMPAIR :

Bumpair WI3 Réf. : PROBUMPW3

Bumpairs assembly

1. Fold the harness at the neoprene cap level
2. Open the zip
3. Slide the 2 bumpairs in
4. Fasten the zip

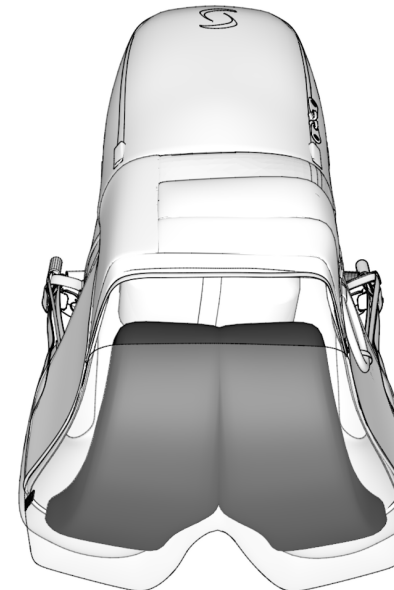
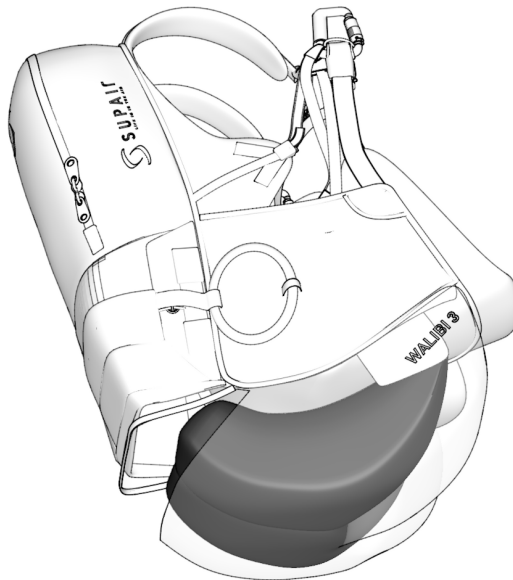
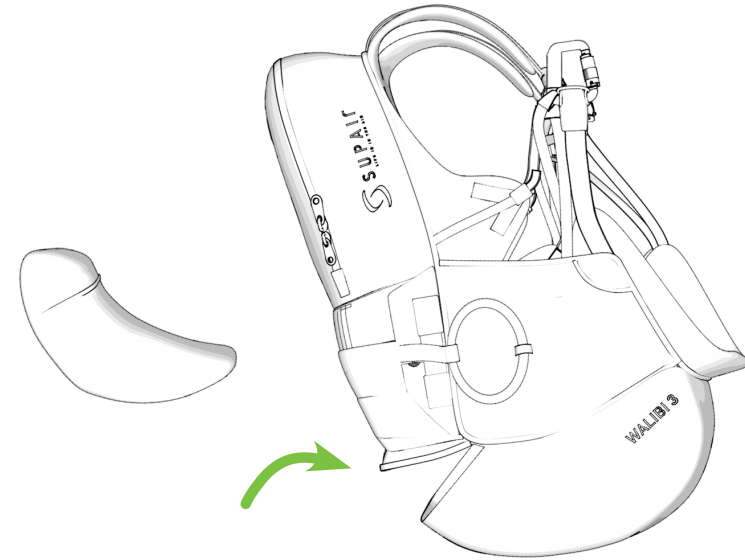

INSTALLING THE RESERVE PARACHUTE



Thank you for reading the following carefully ! We recommend for the initial rescue parachute assembly and installation to be made by a qualified professional.

Reserve parachute folding and installation inside the harness must conform to the specific guidelines found in this manual.

Rescue parachute pocket characteristics

- Panels locked via cables
- Parachute volume 7 to 10,4 liters
- Adapted to all SUPAIR reserve parachutes

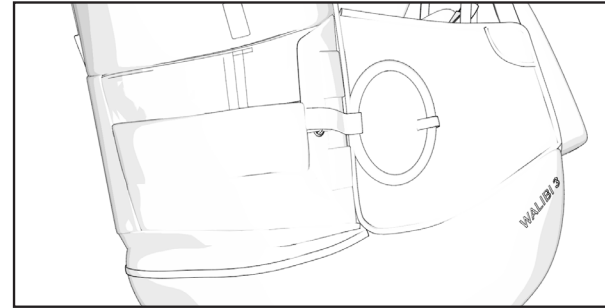

Connecting the handle to the POD

- 1 Fasten the reserve parachute handle bridle to the external pod loop via a Lark's head knot connection.

If you have a large reserve parachute, and feel a slight resistance during the pod extraction hang-test, connect the reserve parachute handle to the side loop instead.

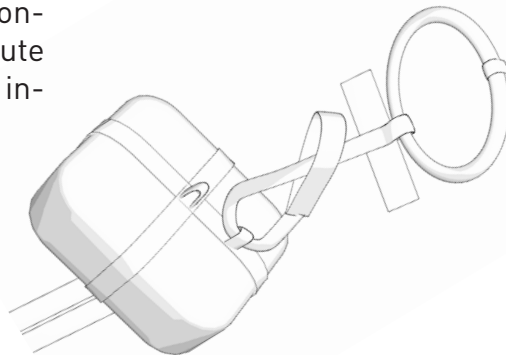

- 2 Tighten the handle/POD connection securely.

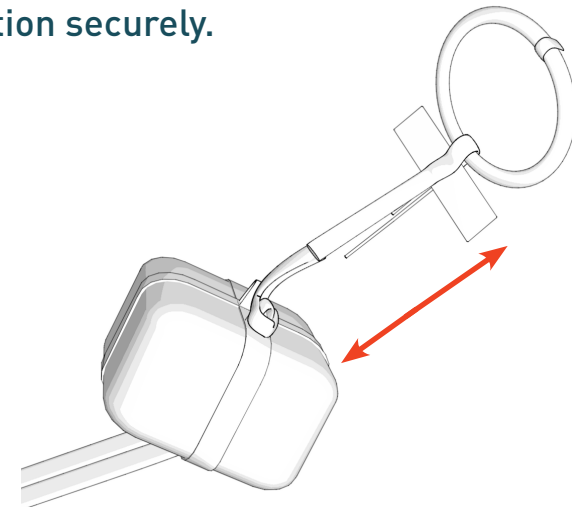

INSTALLING THE RESERVE PARACHUTE

Riser/Harness connection

>> Access to the reserve parachute connection points.

Open the velcro located on the spreader bars to access the parachute's attach points.

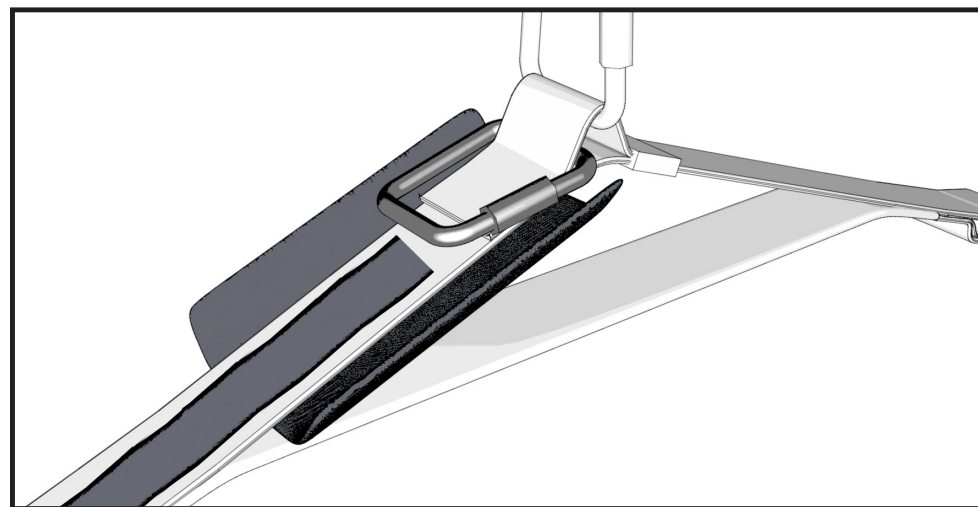
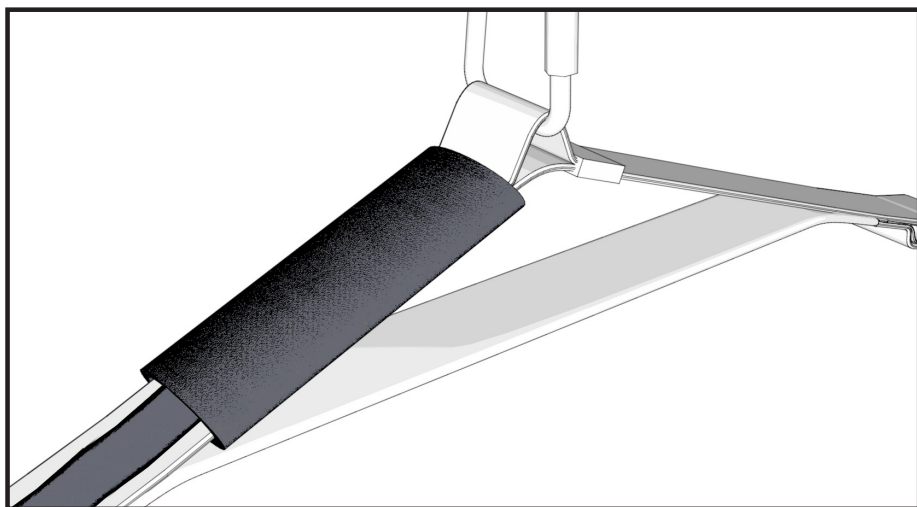

INSTALLING THE RESERVE PARACHUTE

Riser/Harness connection

Fastening the risers to the harness with a set of 7mm square Maillons Rapides®.

Connect each riser to a spreader bar using a squared Maillon Rapide® and O-ring.

1

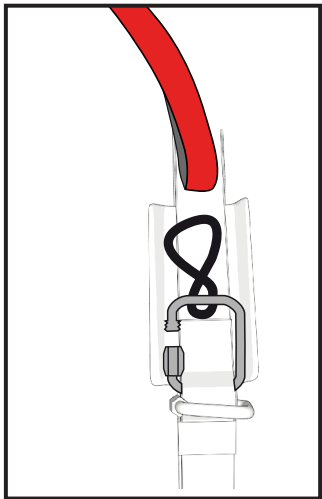

- Open the 7mm maillon Rapide®

- Push the toric ring through the Maillon Rapide® and twist it.

2

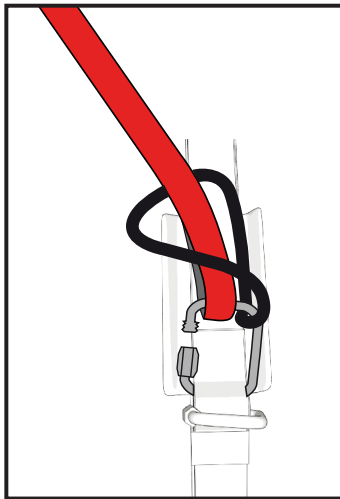

- Push the bridle connecting point through the toric ring loop

- Push the Maillon Rapide® through the bridle connection loop.

3

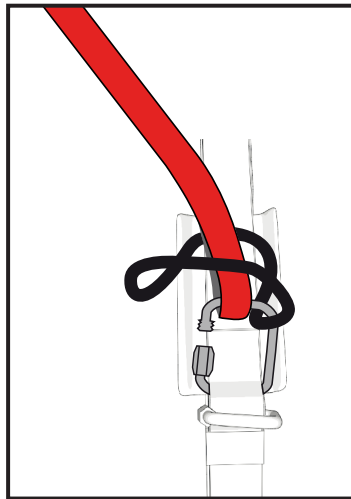

- Give the toric ring a second twist

4

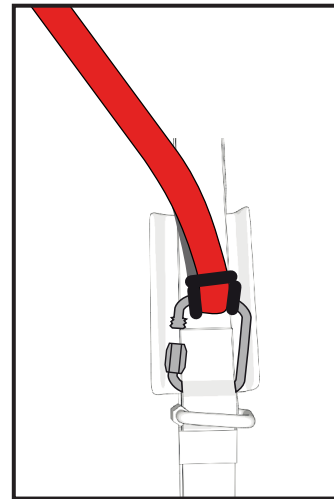

- Push the bridle through the Maillon Rapide®

5

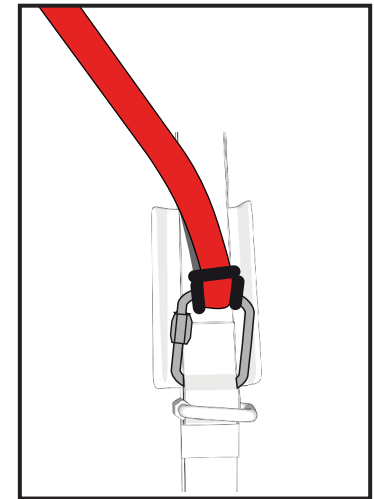

- Close the maillon Rapide® by hand, then tighten using a set of pliers and making a 1/4 turn.

- Repeat the procedure with the second bridle connection loop.

INSTALLING THE RESERVE PARACHUTE

Place the risers inside the neoprene sleeve.

- 1 Pass the right-hand riser inside tearable neoprene sleeve along the spreader bar then the Maillon Rapide's and finally the shoulder straps.

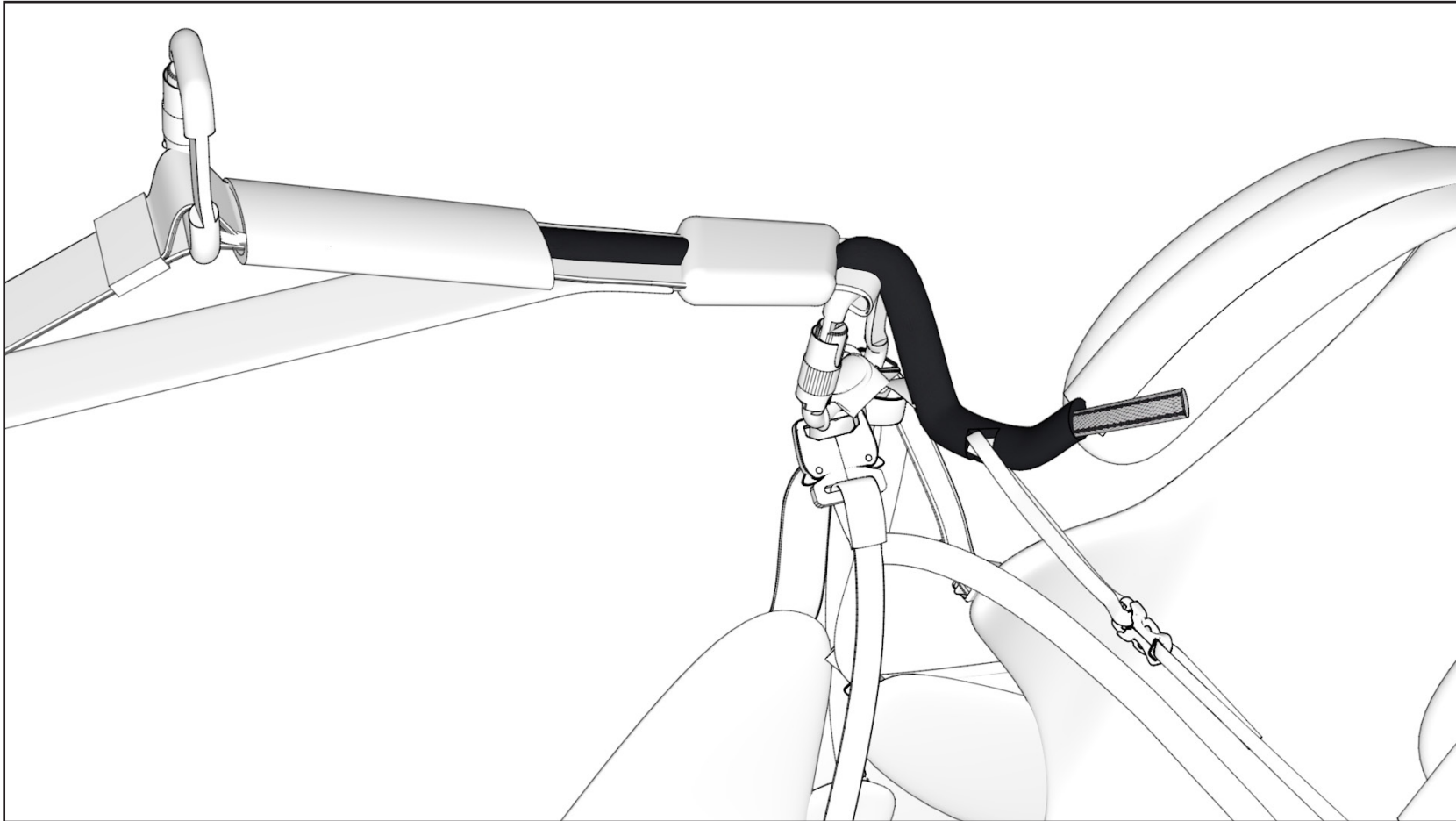

- 2 Repeat the same process for the riser located on the left.

INSTALLING THE RESERVE PARACHUTE

Place the risers inside the sleeve

- 1 Pass the risers through their respective shoulder sleeve.

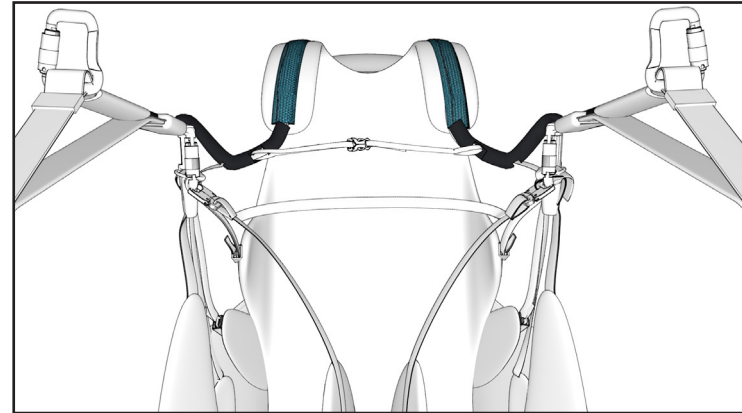
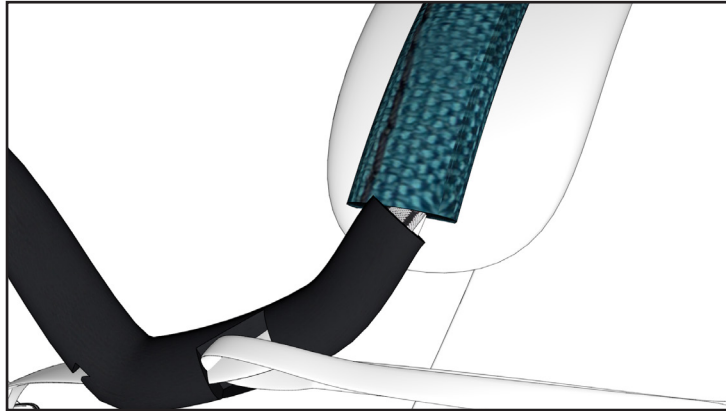

- 2 - Place the risers inside their guiding sleeve connected alongside the harness and bring them out through the reserve parachute container
- Use the Velcro to close the sleeve

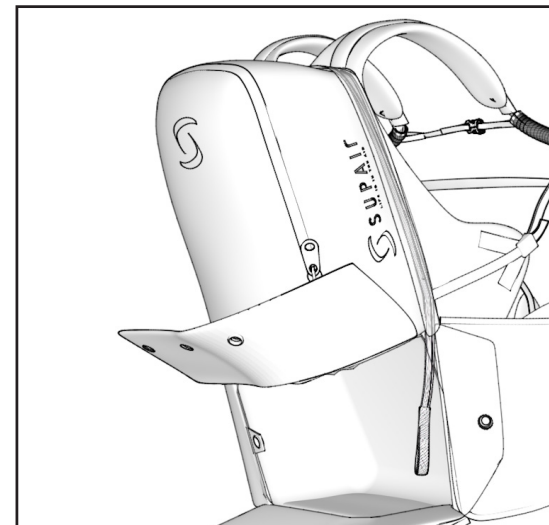
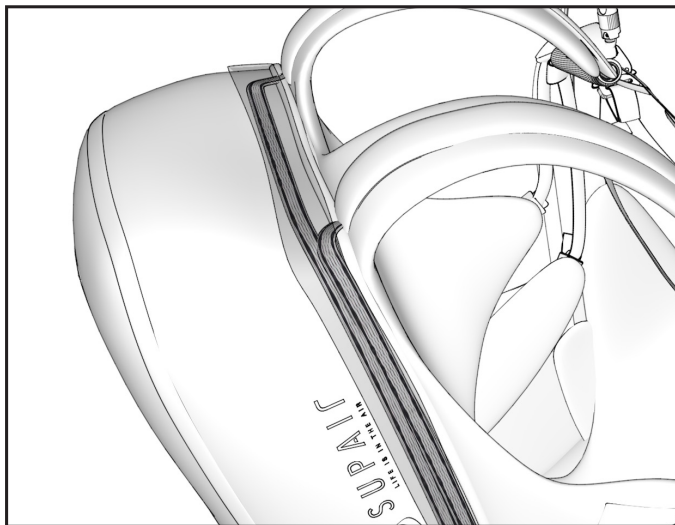

INSTALLING THE RESERVE PARACHUTE

Reserve parachute/risers connection

One (1) square 7mm Maillon Rapide® will be needed + two (2) flexible toric rings.

1

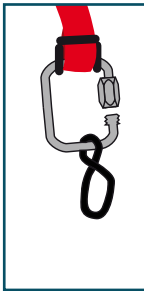

- Open the 7mm square Maillon Rapide®
- Push the maillon through the risers loops
- Push the maillon through the plastic ring
- Twist

2

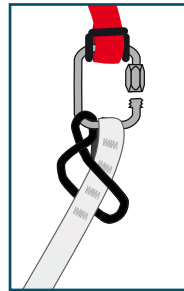

- Push the riser end through the toric ring loop.
- Push the maillon through the riser loop

3

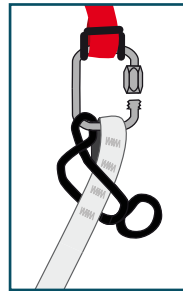

- Give a second twist to the plastic ring.
- Push the buckle through the maillon.

4

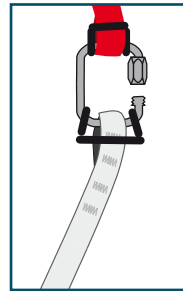

5

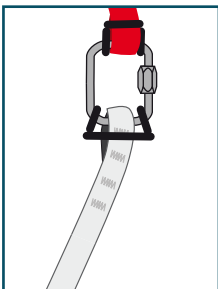

- Tidy up the assembly.
- Be certain for the riser end loops to be securely fastened.
- Close the Maillon Rapide® tightly by hand.
- Tighten using pliers and making a ¼ turn.

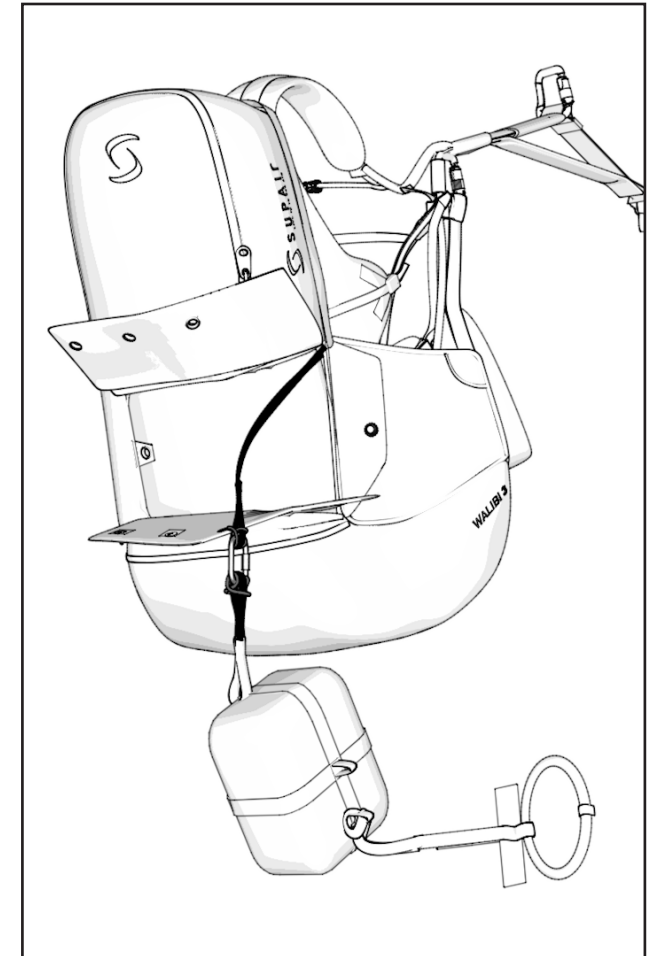

INSTALLING THE RESERVE PARACHUTE

Installing the reserve parachute in its container



Thank you for reading the following carefully ! We recommend for the initial rescue parachute assembly and installation to be made by a qualified professional.

Reserve parachute folding and installation inside the harness must conform to the specific guidelines found in this manual.

The Walibi 3 was not designed to be used with an outer container.

- 1 Place the reserve parachute inside the reserve parachute pocket with the handle on the right side.

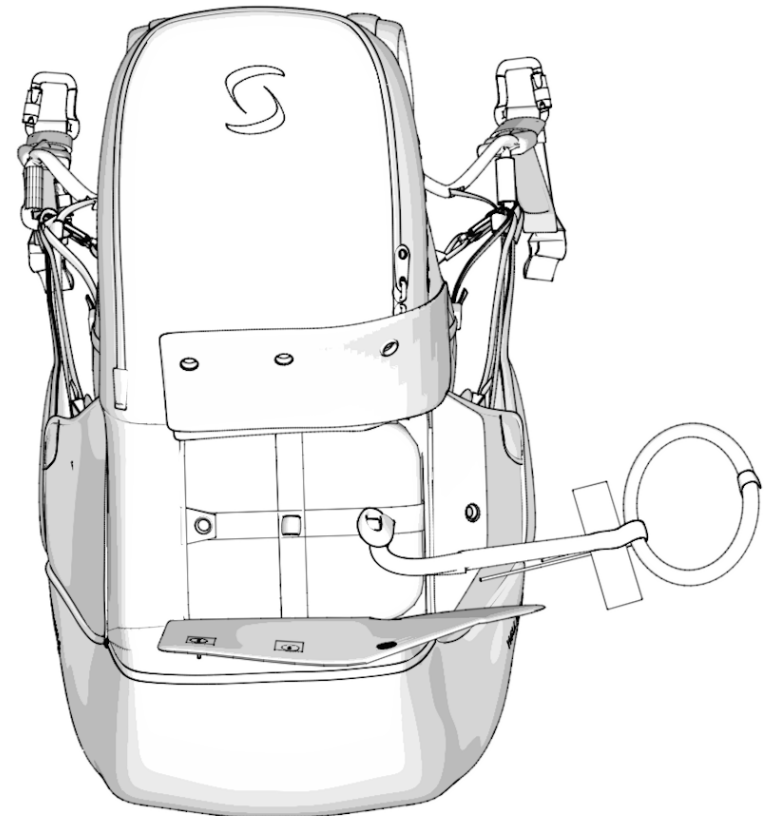

INSTALLING THE RESERVE PARACHUTE

Installing the reserve parachute in its container

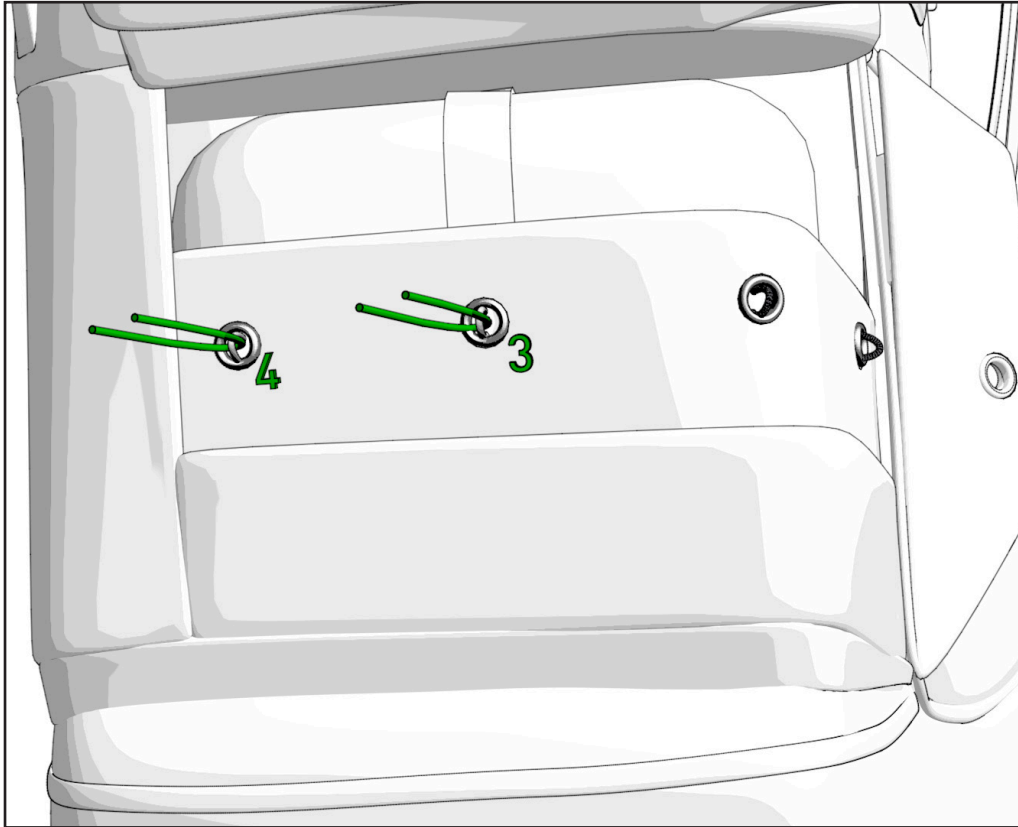

2

Pass the folding rod through the loops number 3 and 4

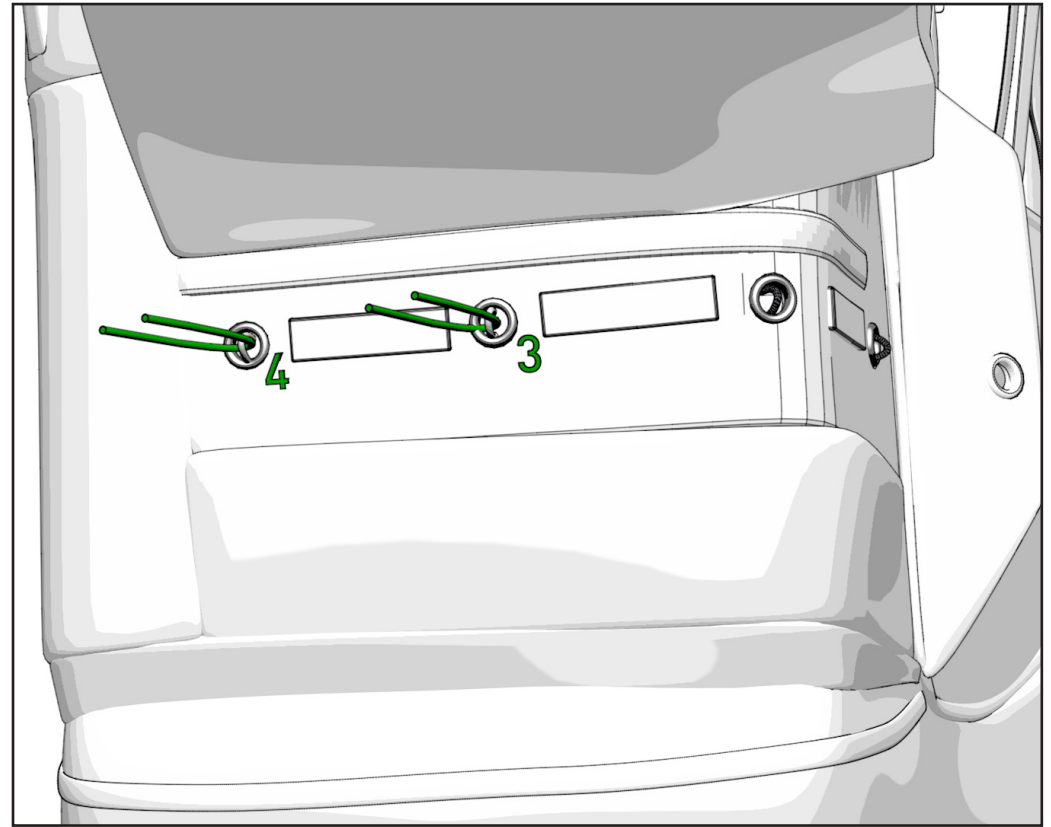

3

- Using the rod, pass the loops 3 and 4 through the gommets
- Store the side ears in their place

INSTALLING THE RESERVE PARACHUTE

Installing the reserve parachute in its container

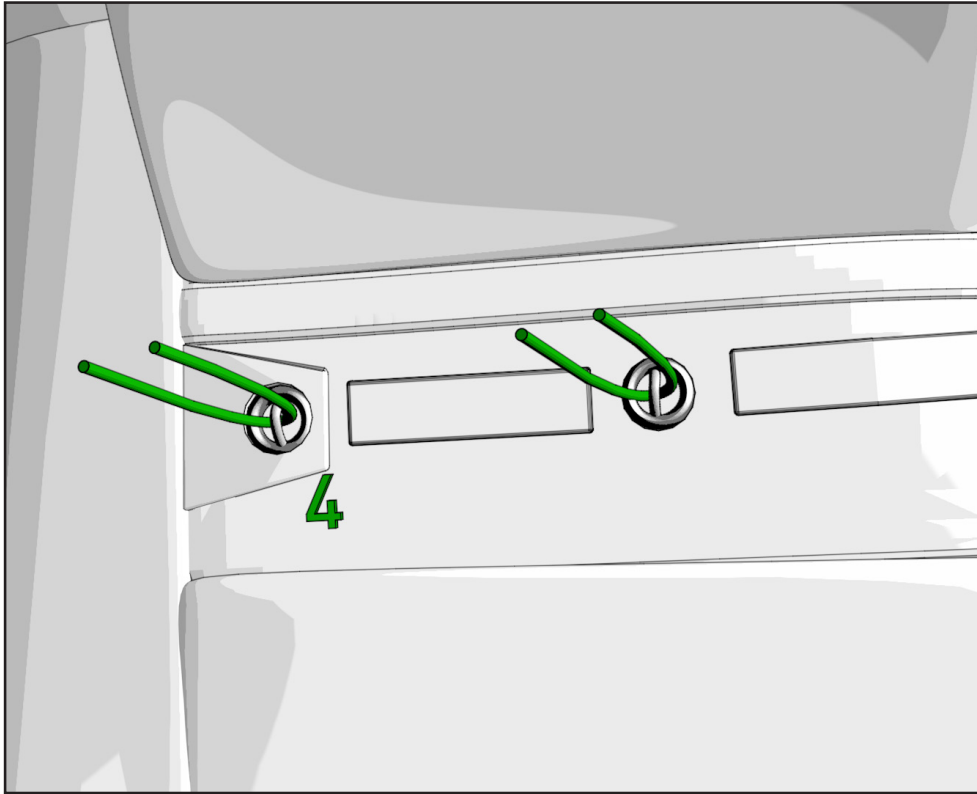

4

Pass the loop 4 through the small side flap

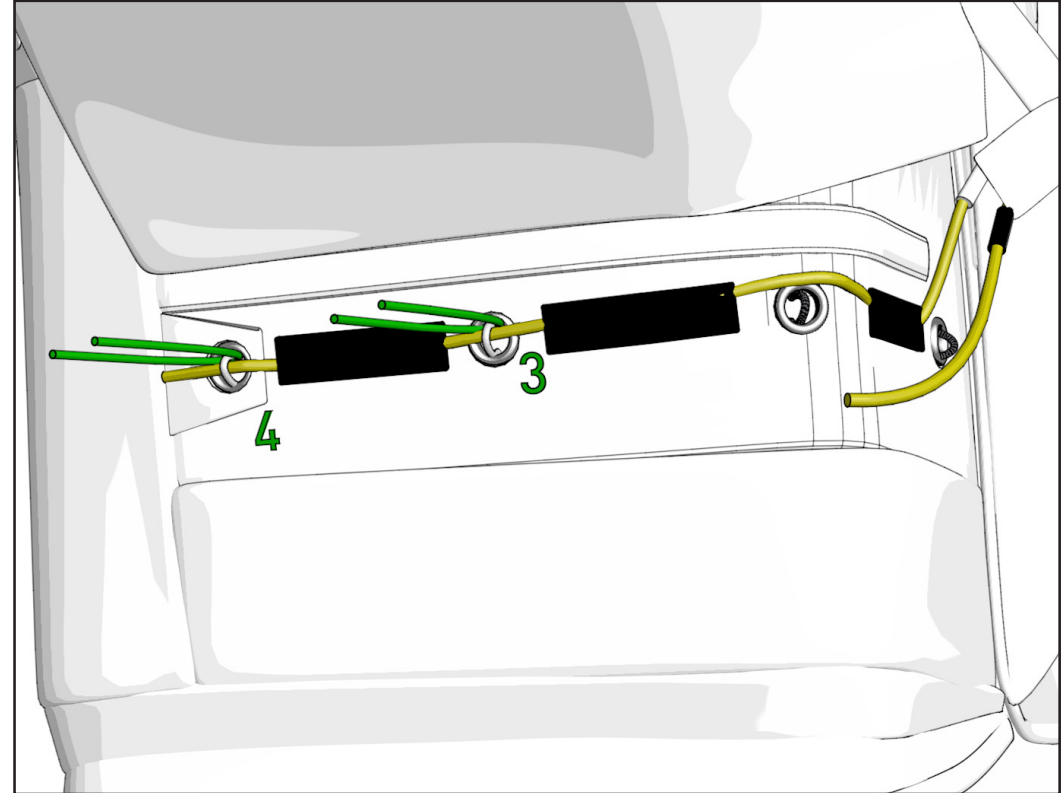

5

Pass the large rod through the guides through the loops 3 and 4 (white loops).

INSTALLING THE RESERVE PARACHUTE

Installing the reserve parachute in its container



WARNING

Do not pass the big rod in black loops 1 and 2

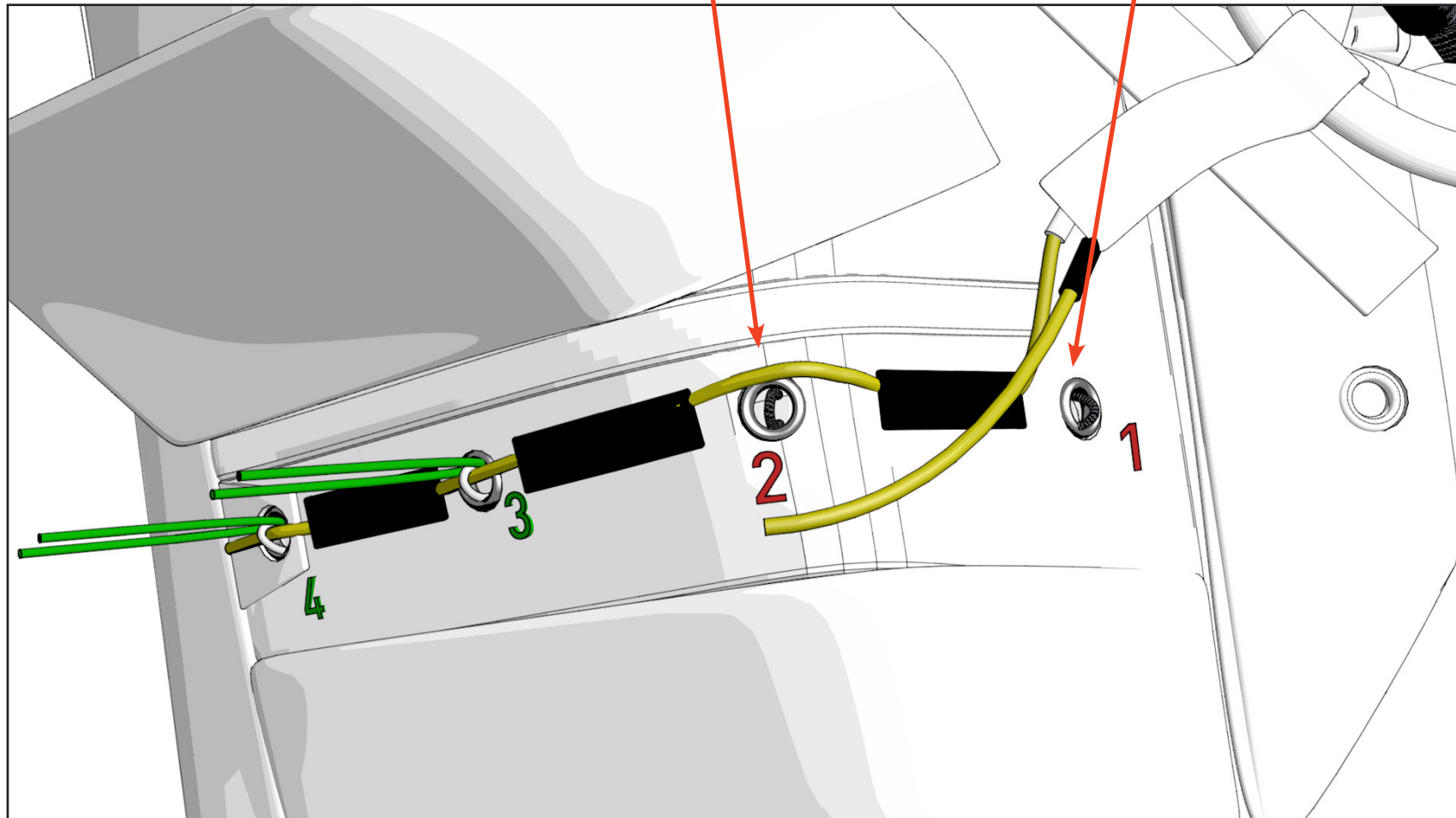

INSTALLING THE RESERVE PARACHUTE

Installing the reserve parachute in its container

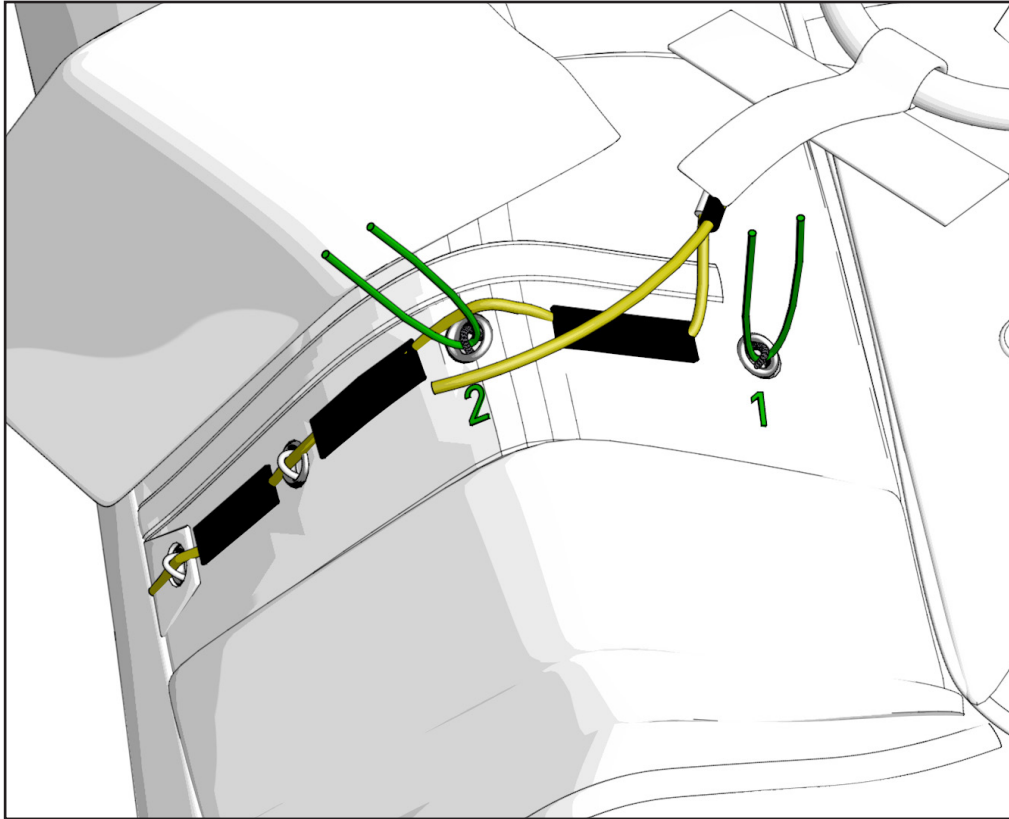

6

Using the rod, pass the loops 1 and 2 through the gommets

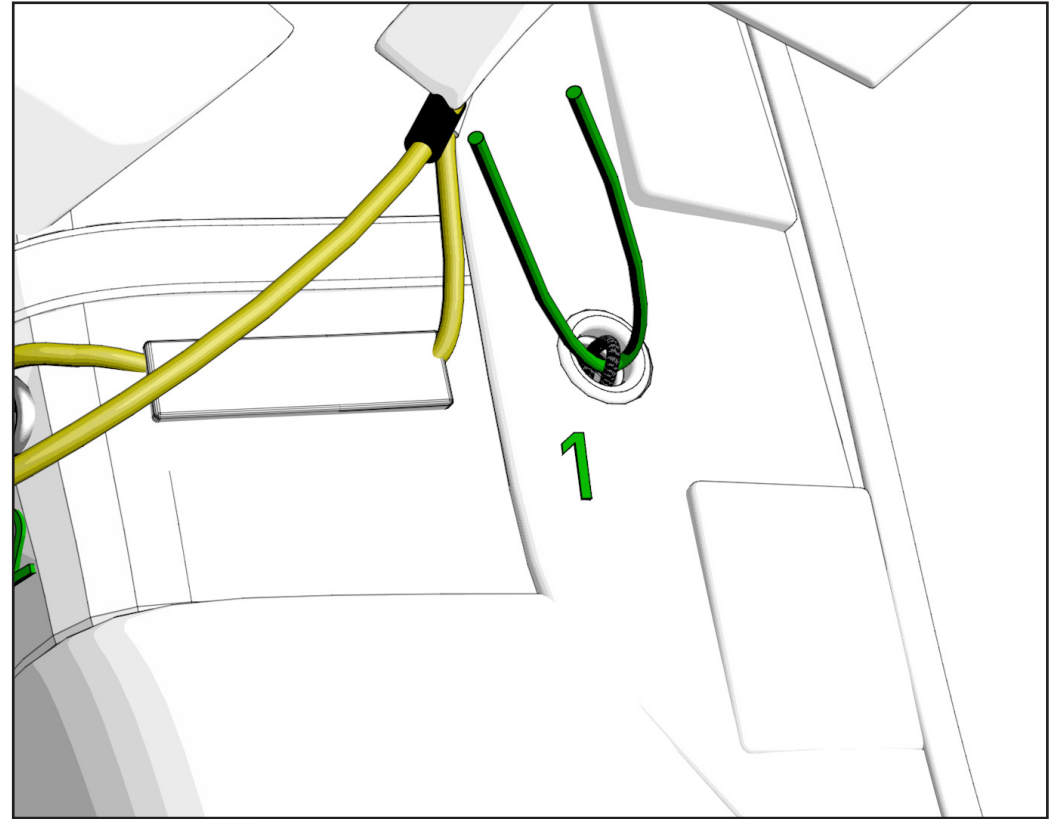

7

Pass the loop 1 in the side flap which will maintain the handle

INSTALLING THE RESERVE PARACHUTE

Installing the reserve parachute in its container

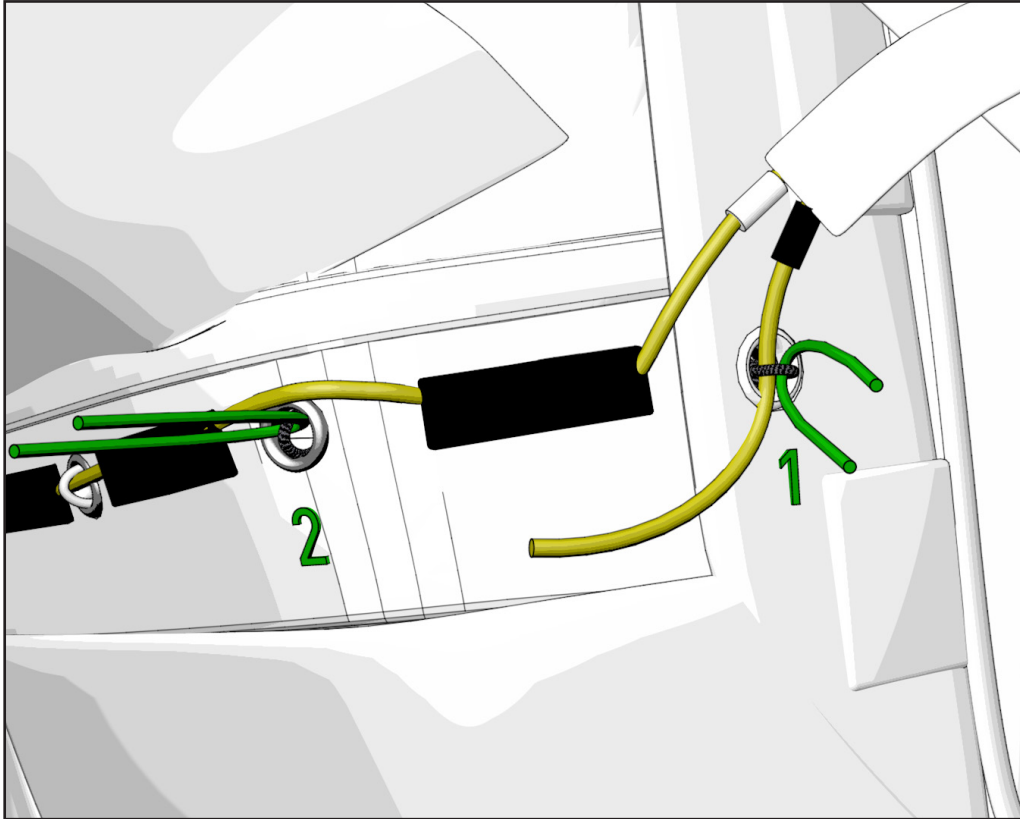

8

Pass the small rod through the loop 1

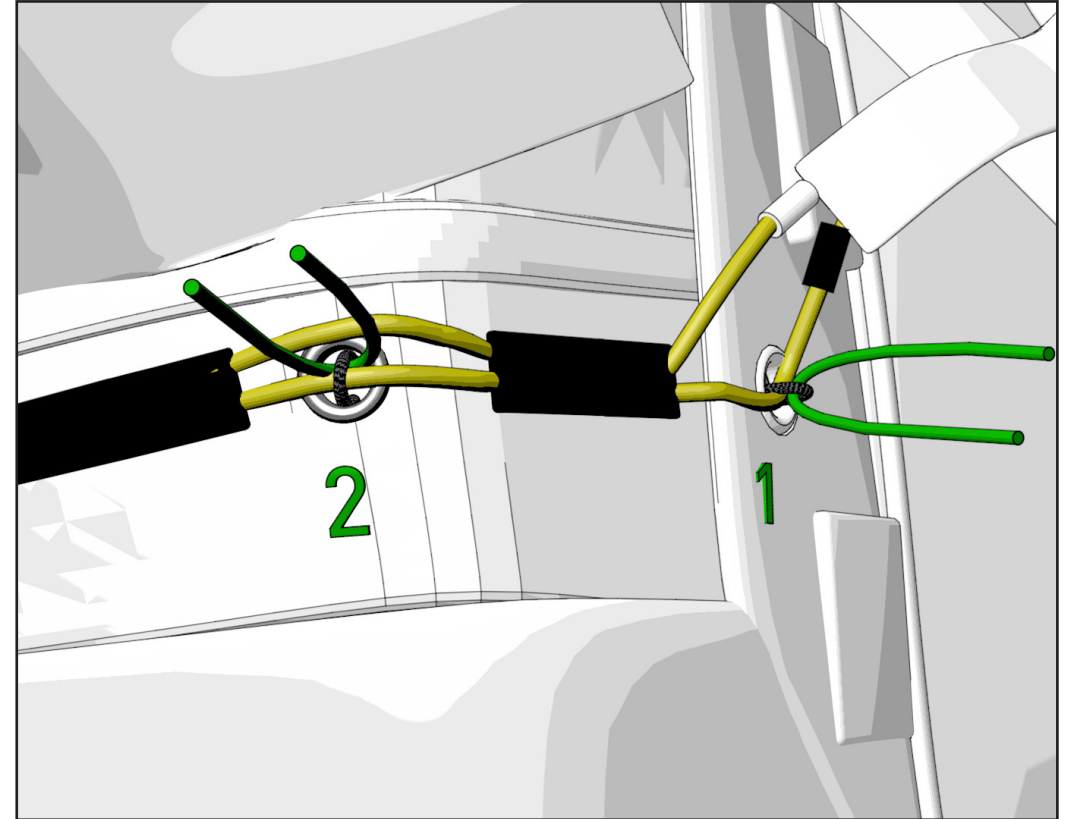

9

Pass the small rod in the guide then in the loop 2 and the second guide

INSTALLING THE RESERVE PARACHUTE

Installing the reserve parachute in its container

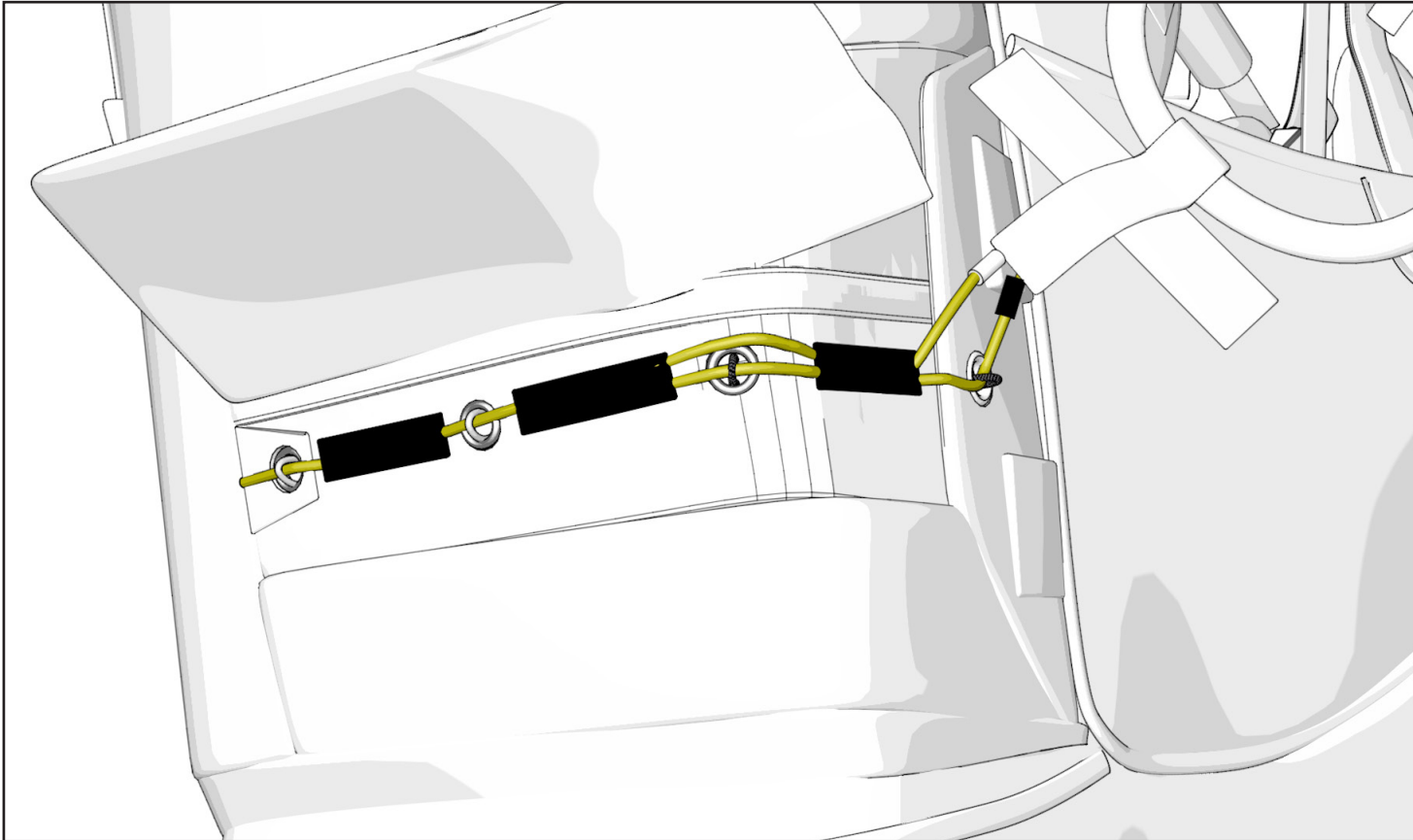

10

Check the mounting. In each of the 4 loops must pass a rod and only one.

INSTALLING THE RESERVE PARACHUTE

Locking the reserve parachute handle

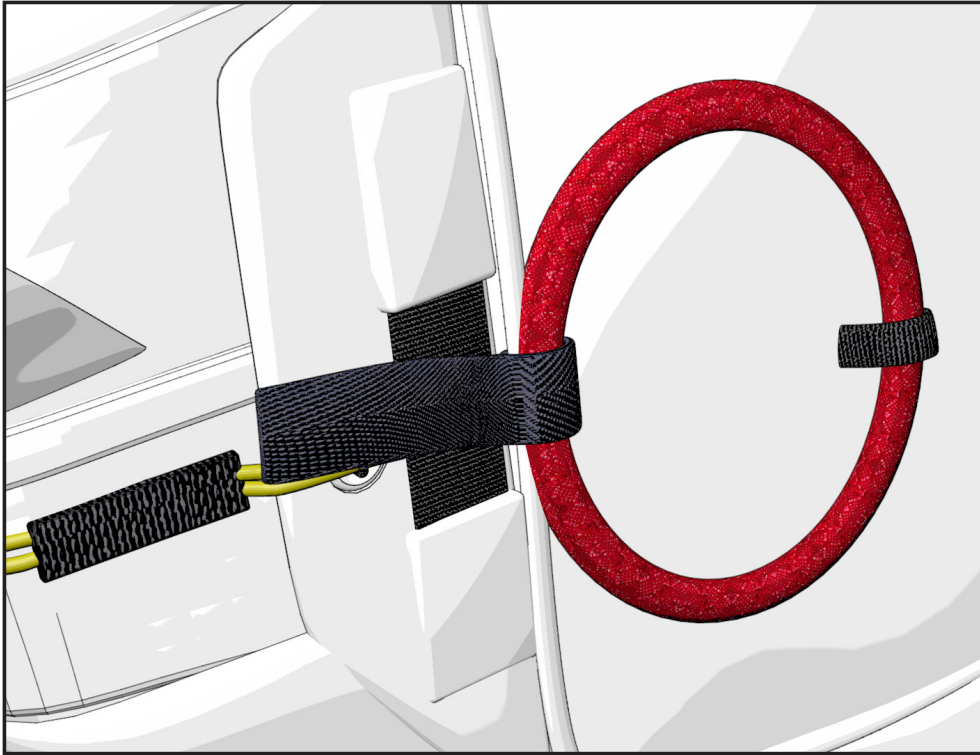

11

Insert the parachute handle in the dedicated support

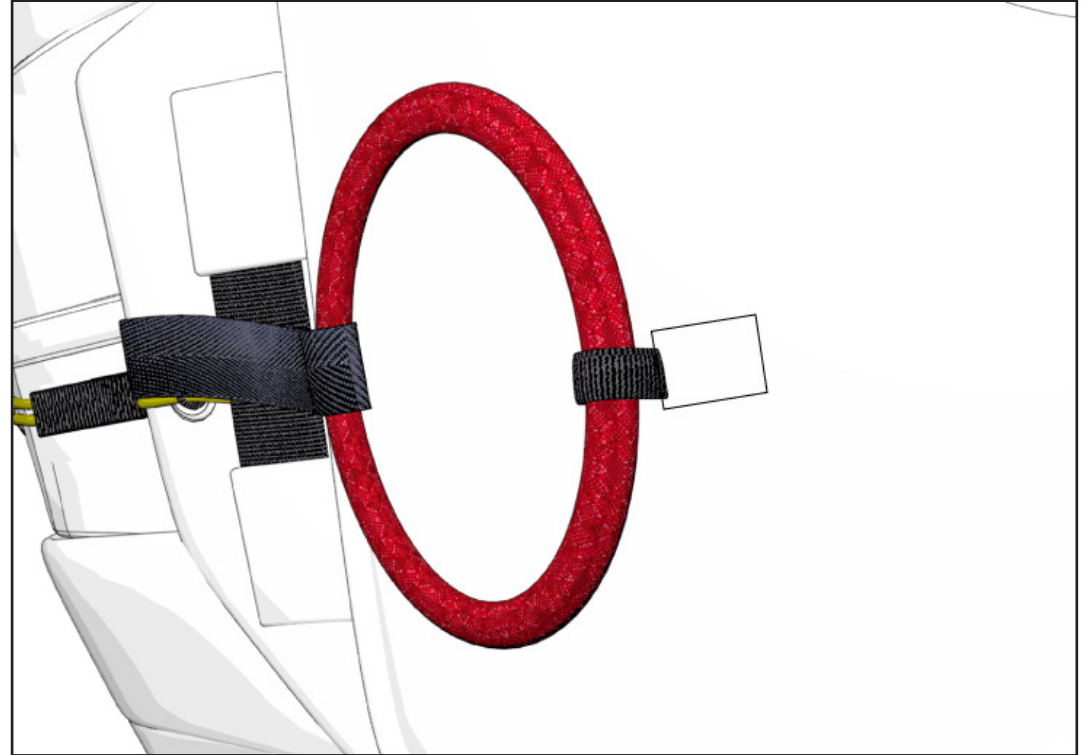

12

Insert the velcro holding the handle into the slot

INSTALLING THE RESERVE PARACHUTE

Locking the reserve parachute container

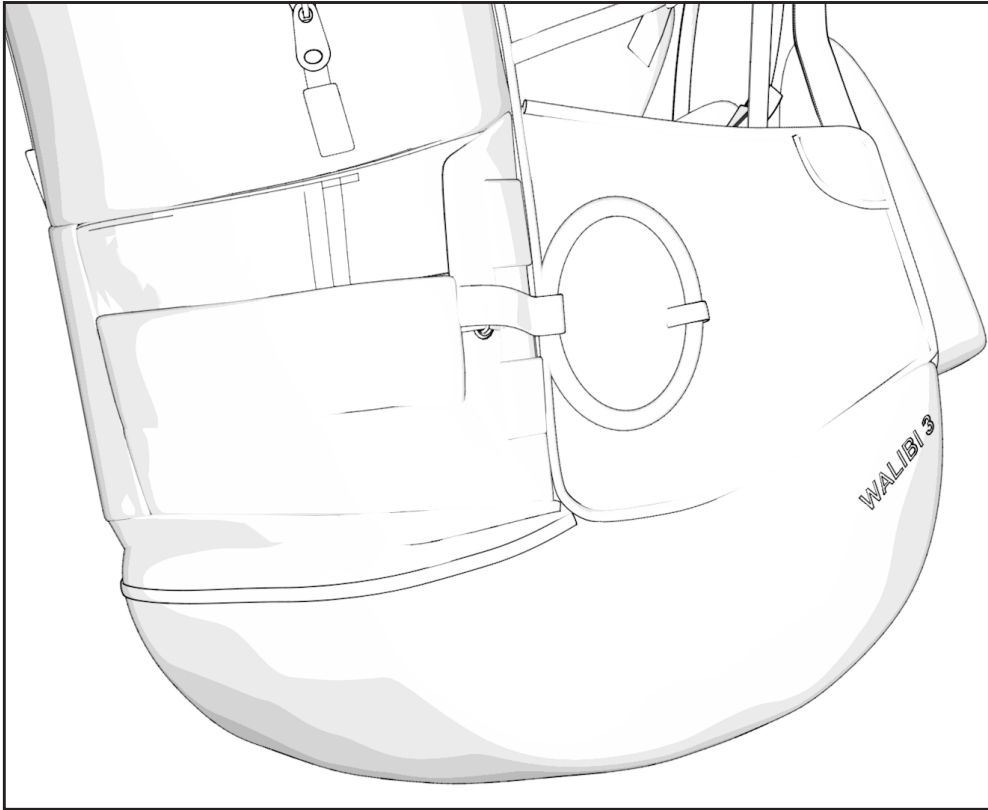

13

Lower the upper flap and slide it into the lower flap.

Mandatory extraction test procedure



Check the completed installation during a hang-test.

Have the installation checked by a professional outfit.
Conduct an extraction test every six (6) months to assure proper system functionality.

Note :
Conducting an extraction test does not imply deploying the reserve parachute which will stay inside its POD.

PACKING AND TIPS

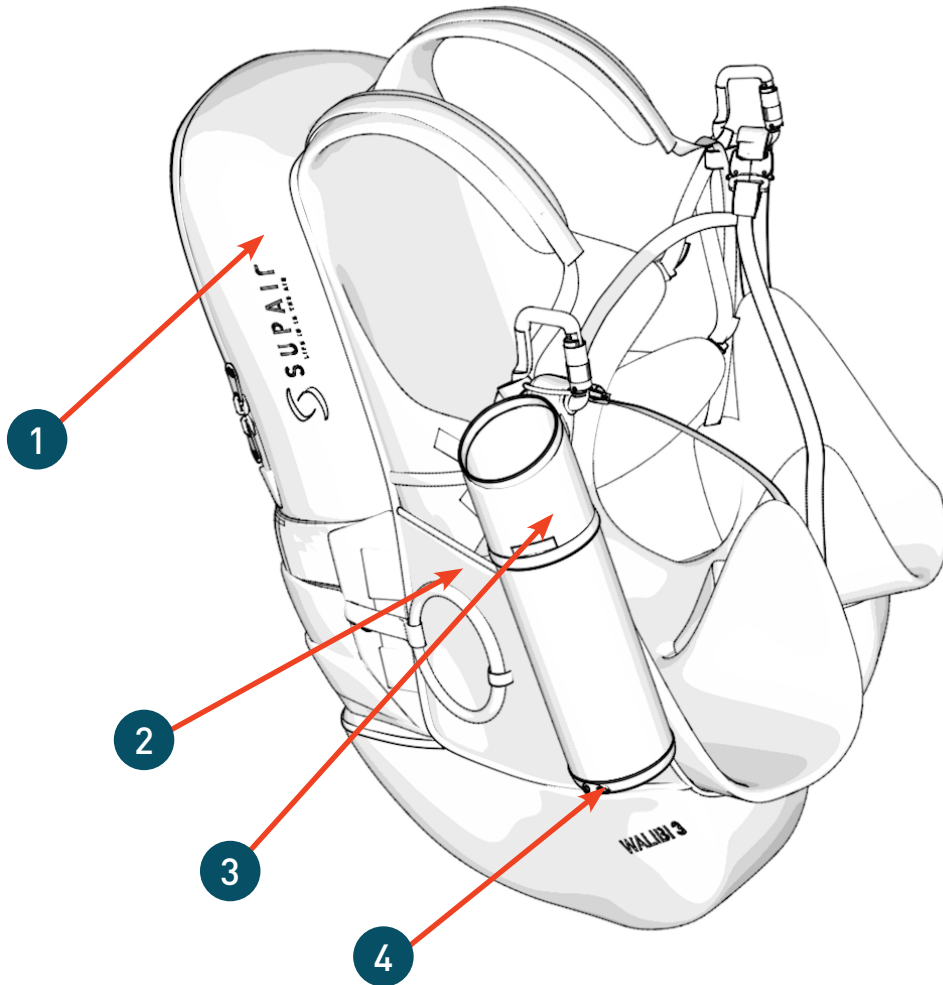

- 1 Back storage pocket
- 2 Small storage pocket
- 3 Camera pocket
- 4 Zipped storage pocket for memory cards



Tip : The main loop is protected by a safety cover

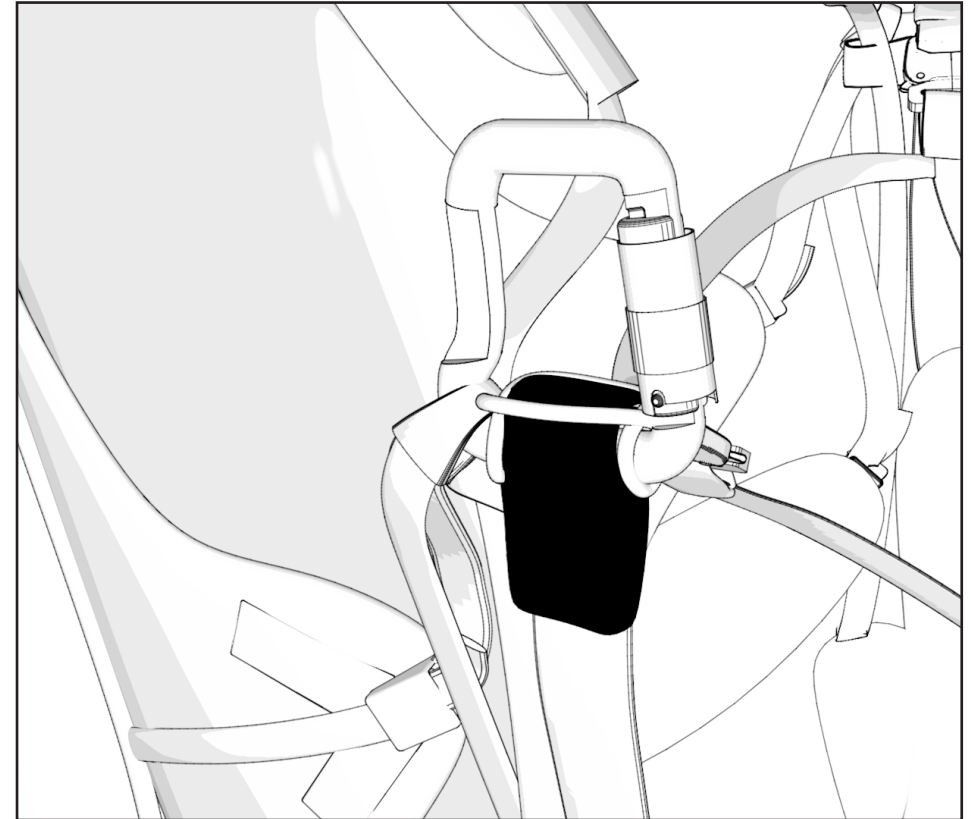

ADJUSTING THE HARNESS



Adjusting the harness prior each takeoff is vital.

The various adjustments

- 1 Adjusting the backrest
- 2 Lumbar support adjustment
- 3 Adjusting the shoulder straps

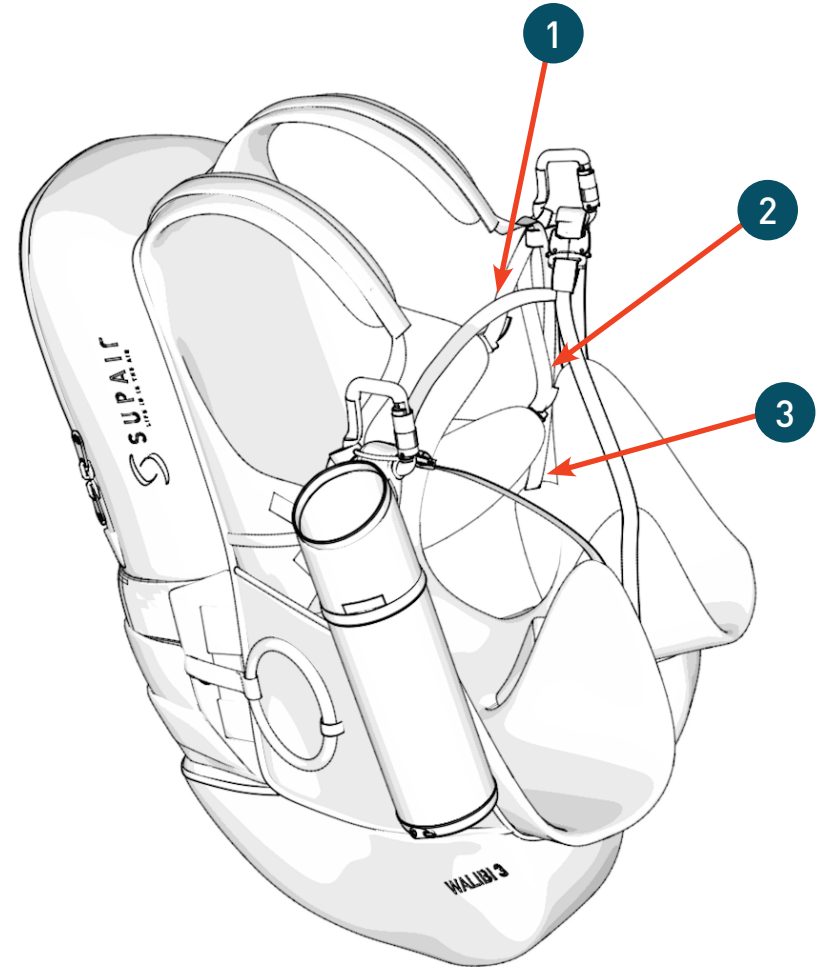
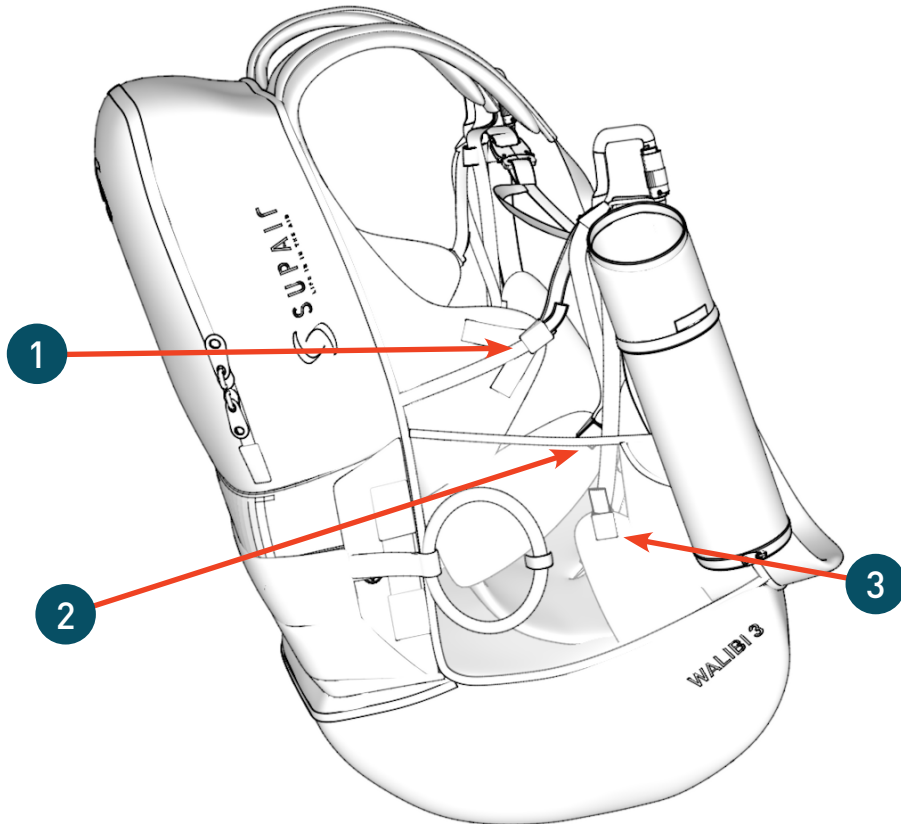

Adjusting the harness



Without strap tension, first adjust the backrest incline at the desired angle.

- Tightening will bring the backrest at a more vertical angle
- Loosening the backrest will tilt the back support rearward.



Adjust the shoulder straps length using the trimmers

The pressure on the shoulder straps contributes to general comfort in flight. It must be precise: not too tight nor too loose. The upper area of the straps must offer enough support to maintain your torso in a comfortable position.

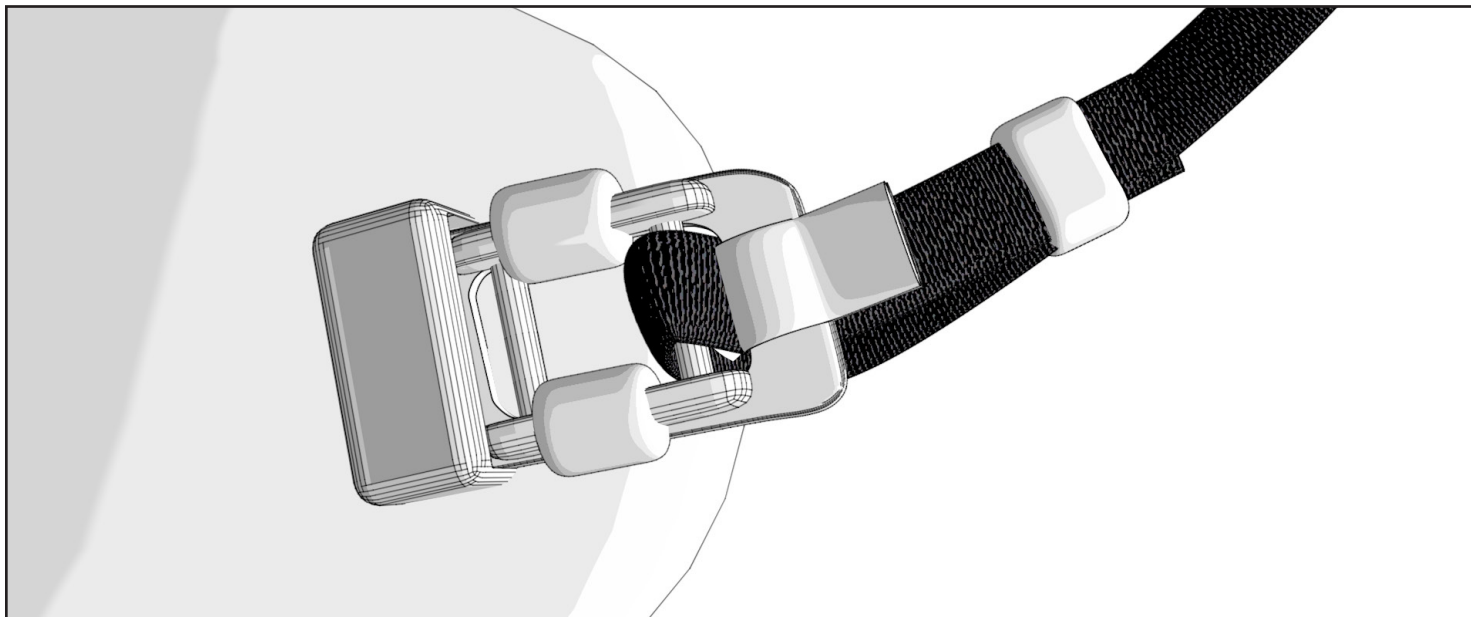

← loosen

tighten →

CONNECTING THE WING TO THE HARNESS

Connecting the wing to the harness

Connect the Walibi 3 harness to the tandem spreader-bars using the loops intended for this purpose

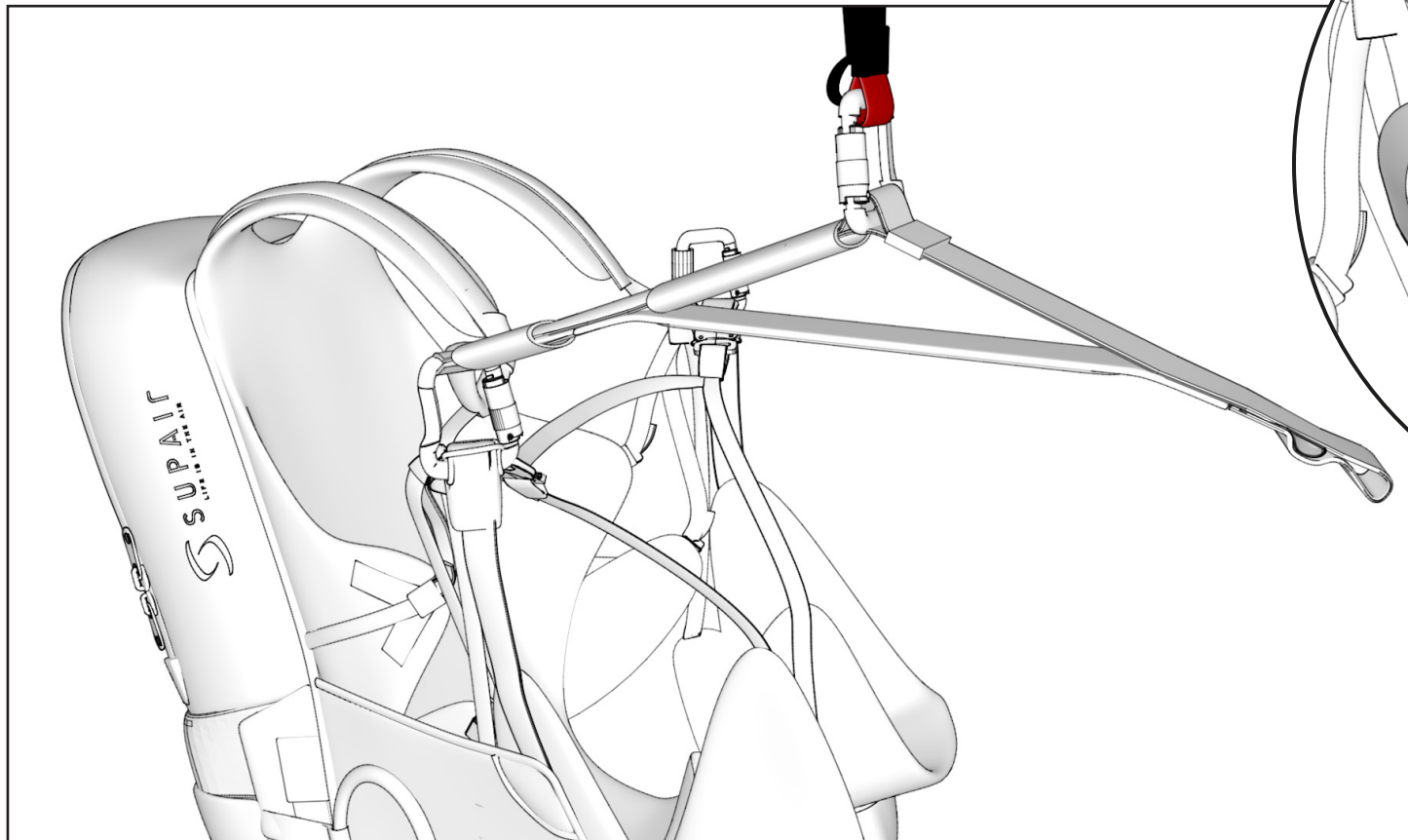

Flight direction →



Pre-Flight control



- Check that the harness, the carabiners, the spreader bar and in general all your flight equipment are not damaged. As the captain, you are responsible for the safety of the crew
- Make sure that the reserve parachute safety cables to ride through the closing tabs keeping the reserve rescue pocket flaps closed.
- Check that your personal settings haven't changed.
- Check that all zippers and buckles are closed.
- Check that none of the glider lines or any object come into contact with the reserve parachute handle(s).
- Make sure that the self-locking carabiners are locked and connected to the paraglider.

Take-off

After a thorough weather conditions analysis, when the decision to fly has been taken, put your harness on and follow the next steps



- Lock the leg / chest automatic buckles

Takeoff maintaining a vertical posture and push yourself inside the harness but only once away from the ridge.



Do not release your hands from the brakes when you are close to terrain.

In flight



Once up in the air, the WALIBI 3 behaviour is stable and instinctive.

Landing



Straighten yourself in your harness and adopt a running posture to dissipate the horizontal speed.

Always be certain to have enough altitude to make a landing approach corresponding to the weather conditions of the moment and terrain. During the landing approach, never make hasty maneuvers. Always land upwind in a standing posture and be ready to run upon touchdown if necessary.

During your final approach, use as much airspeed as possible based on the weather conditions of the moment, then gradually reduce the glider air speed by pushing the toggles all the way down until contact with the ground is made. **Beware not to brake too soon and too rapidly and too deep which could lead to a stall and a dangerous landing.**

During high wind speed landings, turnaround and face the wing as soon as ground contact is made and move toward the wing while braking symmetrically to deflate it. **Do not land in a seated position as it is dangerous.**

TOWING

To takeoff under tow, you must be equipped with a quick release specially designed for the task.

Connect the tow bridle to the wing riser loops with a suitable tow bridle. Installation must follow the tow bridle real manufacturer's recommendations. Before towing, you should consult with a competent towing outfit about safety recommendations.

USING THE RESERVE PARACHUTE

Throwing the reserve parachute



We strongly advise you to check frequently the location of the reserve parachute handle location. To do this, we recommend that you lower your right hand following the risers. This movement should be done without looking. By doing so, you will maximize your chances of a rapid extraction if something went wrong and throwing the reserve parachute was called for.

Estimate your AGL (Altitude Above Ground Level), which if high enough may make it worth trying to bring your wing back to a normal flying configuration. If in doubt, quickly deploy your emergency parachute.



Deploying a rescue parachute should be done only in an emergency.

With a strong, lateral and then vertical tug, pull the handle towards you and then throw the parachute away from you (including the container and its handle) toward a clear unobstructed area of the sky. As soon as the parachute deploys, bring as much of the glider as possible toward you by pulling as symmetrically as possible on the "C" or "D" risers or on the toggles/brakes.

Once the rescue parachute is opened, get your passenger and yourself ready for landing : upright posture, legs slightly bent, ready to roll by rotating your shoulders

MANDATORY CONTROLS

Mandatory biannual inspection :



- Ascertain parachute deployment functionality by pulling the handle to activate a clean POD extraction sequence
- Inspect the harness for wear and tear

Annual check :



An annual deployment and repacking of the reserves parachutes must be conducted by competent and certified personnel.

Call for help after an accident

Emergency call numbers



EUROPE / INDIA	112
USA / CANADA	911
CHINA / JAPAN	119
NEPAL	101
IRAN	112
AUSTRALIA	000
NEW ZEALAND	111

Help needed?

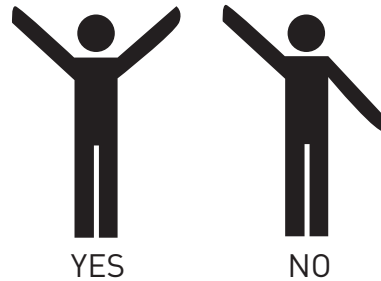

Flashlight SOS :



Harness cleaning and maintenance

It is a good idea to clean your harness from time to time. We recommend using a brush and soft solvents only (soap or mild cleaning agents). Rinse thoroughly. Never use aggressive chemicals such as strong solvents which could be harmful to the harness's fabric, webbings, stitching and weaken its integrity.

The zip fasteners should be lubricated from time to time, using a silicon spray.

If you regularly use your harness in a dusty environment (dirt, sand, etc...), we advise you to regularly check and maintain your carabiners and buckles : clean them with a mild detergent, then blow dry them fully but **DO NOT LUBRICATE !**

Prior to using them, conduct a thorough carabiners and buckles checkup to insure their full functionality.

If you use your harness in a marine/sandy/salty environment, pay particular attention to your gear and follow a rigorous care/maintenance routine.

Storage and transport

When not in use, your harness should be stored inside your paragliding backpack, in a dry, cool and clean place, protected from UV exposure. If your harness is wet, please dry it thoroughly before storing.

For transport, protect the harness from any mechanical or UV deterioration (use a bag). Please avoid long transports in wet conditions.

Life span



Once every two (2) years, a thorough harness inspection must be conducted :

- Webbing wear and tear (no excessive wear, no rip beginning, no unwanted folds)
- Buckles and carabiners (functionality, wear and tear).



The threads and fabric used for the manufacturing of the WALIBI 3 were specifically selected for their quality and resilience levels. However, in particular instances such as long term UV exposure, abrasion, contact with damaging chemicals, general wear and tear, the harness will need to be inspected at a professional certified repair facility. Safety comes first!



Supair advice to replace the carabiners and spreader bars every 5 years or after 500 hours of use.
The self-locking carabiners are NEVER to be used for any activities other than paragliding.

Repair

In spite of using the highest quality products to manufacture the WALIBI 3, it is possible for your harness to deteriorate through general use. If showing any sign of wear and tear, it should be sent for inspection and/or repairs at a professional certified facility.



SUPAIR now offers an extended warranty period reaching beyond the product standard protection plan against manufacturing defects. Please contact us either by telephone or by e-mail sav@supair.com in order to receive a quotation..

Hardware & Parts

- Self-locking zicral 45mm carabiners (référence : MAILCOMOUS 45)
- Bumpair (réf : PROBUMPW3)
- Walibi handle (réf : POWI3)
- Tearable neoprene sleeve (a free kit will be send) (réf : GAINEELEVW3)
- Camera pocket (réf: POCHECAMW3)

Materials

Fabrics

Nylon ripstop 210D
Cordura 500D

Webbings

PA 15mm (850 daN)
PES 25mm (1250 daN)

Recycling

We have minimized our manufacturing footprint by carefully selecting environmentally friendly materials; most of our components are recyclable.

If you estimate that your WALIBI 3 has reached the end of its life span, you can separate plastics from metals and recycle them according to your community rules in effect. As for the fabric itself, contact your local authorities to find out how to proceed to discard it.

WARRANTY

SUPAIR takes the greatest care in its products design and manufacturing and hence offers a five (5) year limited warranty from the date of purchase against manufacturing defects or flaws occurring during normal use. Any damage or degradation resulting from incorrect or abusive use, abnormal exposure to aggressive factors, including, but not limited to; high temperature, intense sun exposure, high humidity etc, will invalidate this warranty.

DISCLAIMER



Paragliding is an activity requiring specific skills and sound judgement. Learn how to fly within the environment of a certified paragliding school. Carry an insurance policy with you in addition to your pilot certification. Always mind and gauge your personal skills relative to the elements you want to be flying in. Better be safe than sorry ! SUPAIR can not be held responsible for your paragliding decisions or activities.



This SUPAIR product has been designed exclusively for paragliding. Any other activity such as skydiving or BASE jumping is absolutely forbidden.

PILOT'S GEAR



It is essential for you to wear a suitable head protection (certified paragliding helmet), boots and right clothing for the activity. Moreover, carrying a reserve parachute connected to your harness in flight is highly recommend.

BUMPAIR Shock Absorber

The harness you have just purchased has a BUMPAIR type shock absorber.

This protection is intended to protect you against potential impacts. It complies with EU Regulations 2016/425 relating to personal protective equipment (PPE).

The shock absorber CE conformity of your harness is certified by the following laboratory: ALIENOR CERTIFICATION n ° 2754, Z.A. du Sanital, 21 Rue Albert Einstein, 86100 Chatellerault, FRANCE

The storage, transport and maintenance of the BUMPAIR is the same as it is for the harness. The inspection of the protector is the same as it would be for the harness.



Please note that no shock absorber can guarantee total protection against injury. The back protector does not prevent potential injuries to the spine and/or pelvis. In addition, only the parts of the body covered by the shock absorber are likely to benefit from adequate protection against possible impacts.



Please note that the performance of the equipment can be dangerously affected by any modification made or improper use of the shock absorber, and negatively affect the proper functionality of the protector which must be whole and properly installed. You must check that all is in order prior each flight:

- The correct installation of the BUMPAIR shock absorber.
- The BUMPAIR seams and overall condition of the fabrics - look for holes, tears, snags



The protection can have a five (5) year lifespan under normal use conditions.
Warning! Following a major hard landing would justify the protector to be discarded.

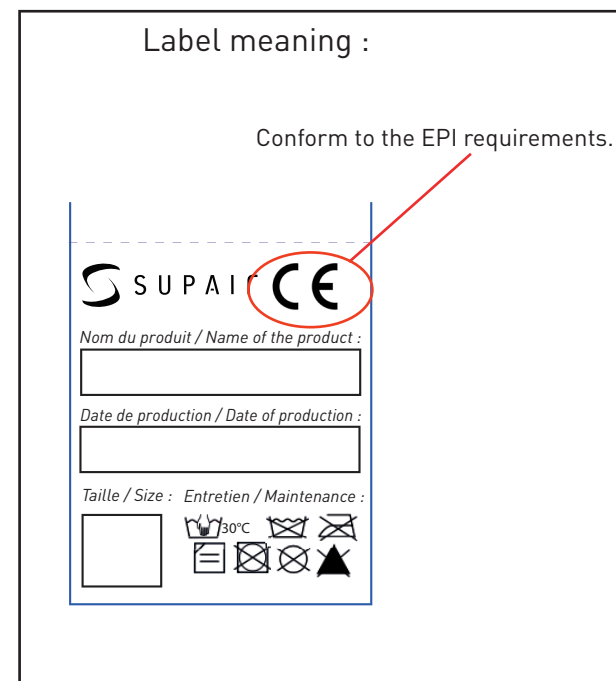

If your BUMPAIR is damaged, have it inspected and repaired at a professional qualified facility or contact us at sav@supair.com

The test results and the EU declaration of conformity can be found at: www.supair.com

This page will help you keep record of your WALIBI 3 scheduled maintenance.

Purchase date	
Owner's name :	
Name and stamp of the shop :	

<input type="checkbox"/> Care	
<input type="checkbox"/> Resale	
Date	
Workshop's name/ Buyer's name	

<input type="checkbox"/> Care	
<input type="checkbox"/> Resale	
Date	
Workshop's name/ Buyer's name	

<input type="checkbox"/> Care	
<input type="checkbox"/> Resale	
Date	
Workshop's name/ Buyer's name	

<input type="checkbox"/> Care	
<input type="checkbox"/> Resale	
Date	
Workshop's name/ Buyer's name	



SUPAIR-SAS
Parc Altaïs
34 rue Adrastée
74650 Chavanod, Annecy
FRANCE

info@supair.com
+33 4 50 45 75 29

RCS 387956790

■ ■ DESIGNED
■ ■ IN ANNECY

 100% MADE
IN EUROPE